

NUKRE 52 C DZ FAG

Cam followers

TYPE: Roller bearings, Stud type track rollers, With axial guidance, full complement cylindrical roller set, with eccentric collar, labyrinth seals on both sides, cylindrical outer ring

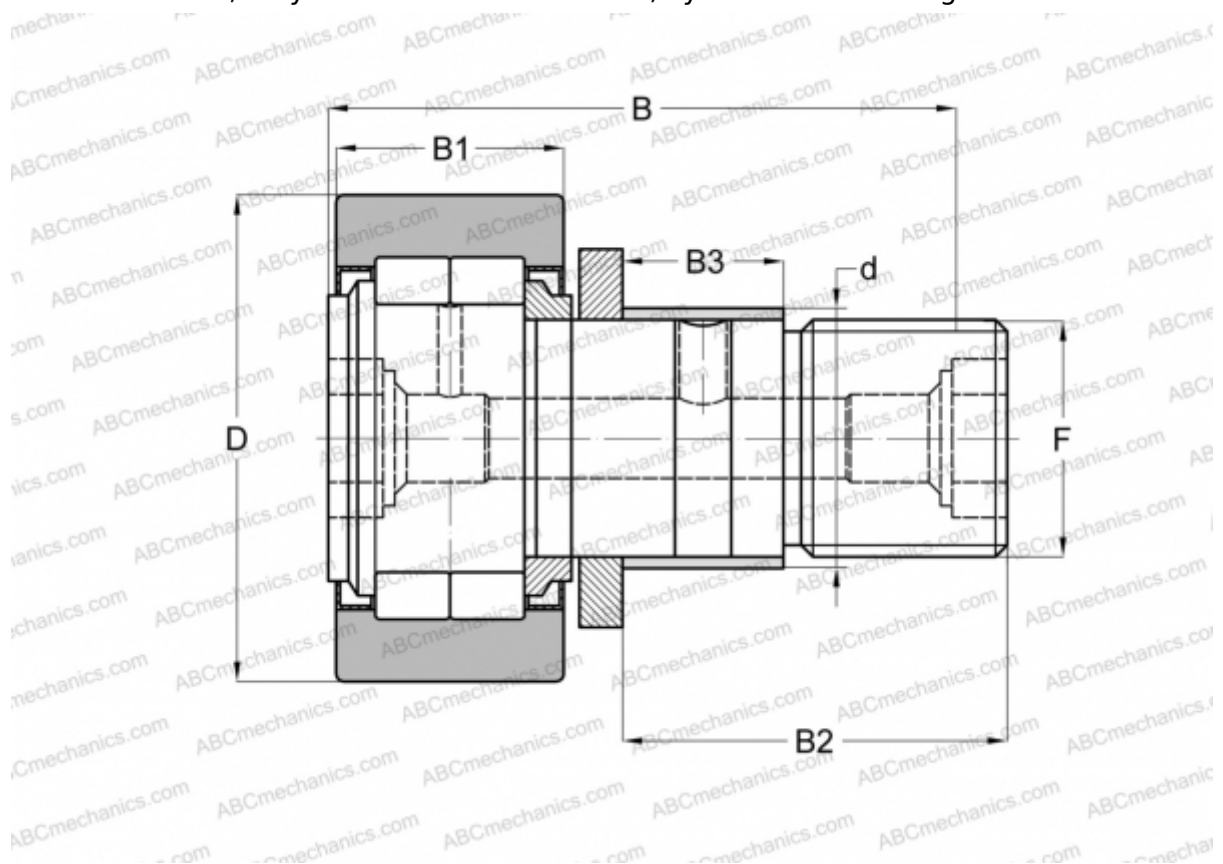

Technical specification

DIMENSIONS, MM

d	24,000
D	52,000
B	66,000
B1	24,000
B2	40,500
B3	18,000
F	M20x1,5

WEIGHT, KG 0,472

MANUFACTURER [FAG](#)

INTERCHANGE

ABC	NUKRE 52 X
INA	NUKRE 52 X
SKF	NUKRE 52 X