

## NUKRE 52 X SKF

Cam followers

TYPE: Roller bearings, Stud type track rollers, With axial guidance, full complement cylindrical roller set, with eccentric collar, labyrinth seals on both sides, cylindrical outer ring

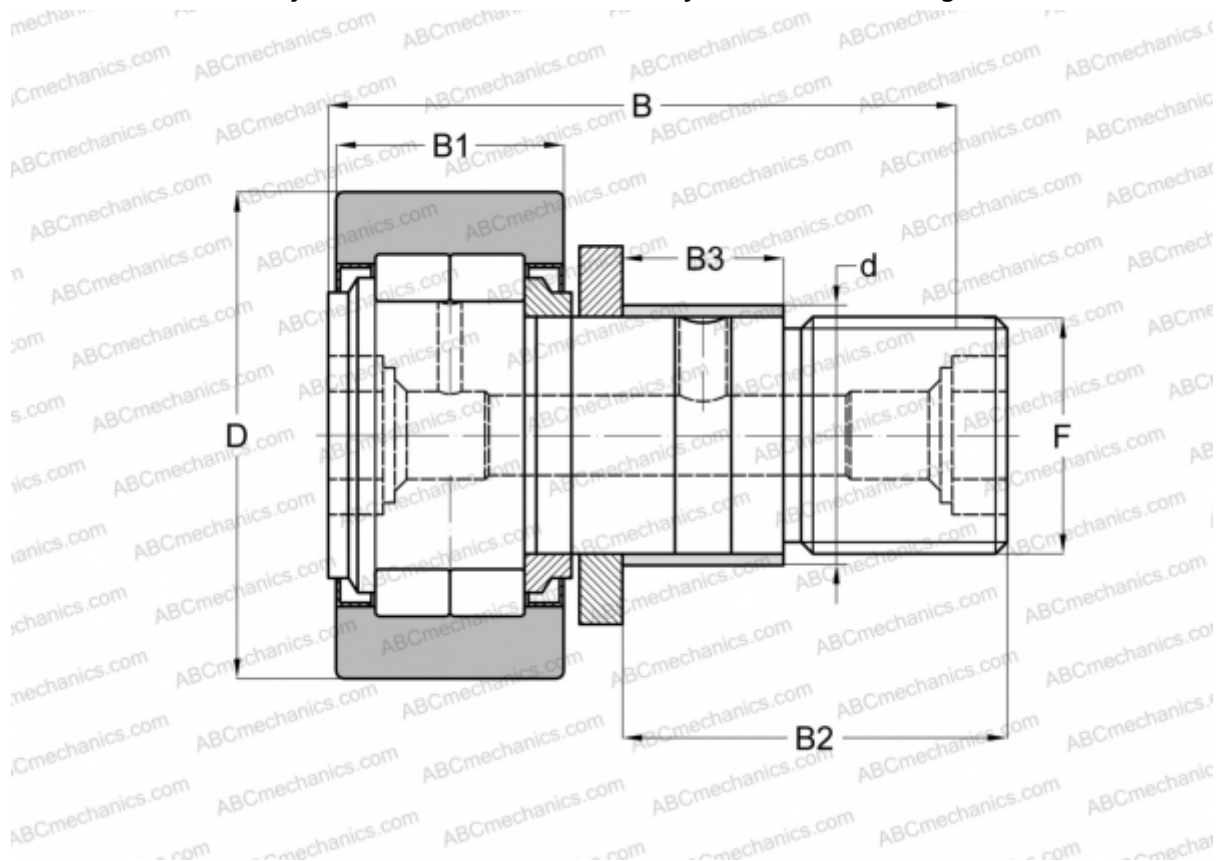

### Technical specification

#### DIMENSIONS, MM

d	24,000
D	52,000
B	66,000
B1	24,000
B2	40,500
F	M 20x1.5

**WEIGHT, KG** 0,470

**MANUFACTURER** [SKF](#)

#### INTERCHANGE

ABC	<a href="#">NUKRE 52 X</a>
FAG	<a href="#">NUKRE 52 C DZ</a>
INA	<a href="#">NUKRE 52 X</a>

#### CALCULATION DATA

Basic dynamic load rating, C	29,700 kN
Basic static load rating, Co	36,000 kN
Fatigue load limit, Pu	4,250 kN
Limiting speed	3200 r/min