

NUKRE 62 X INA

Cam followers

TYPE: Roller bearings, Stud type track rollers, With axial guidance, full complement cylindrical roller set, with eccentric collar, labyrinth seals on both sides, cylindrical outer ring

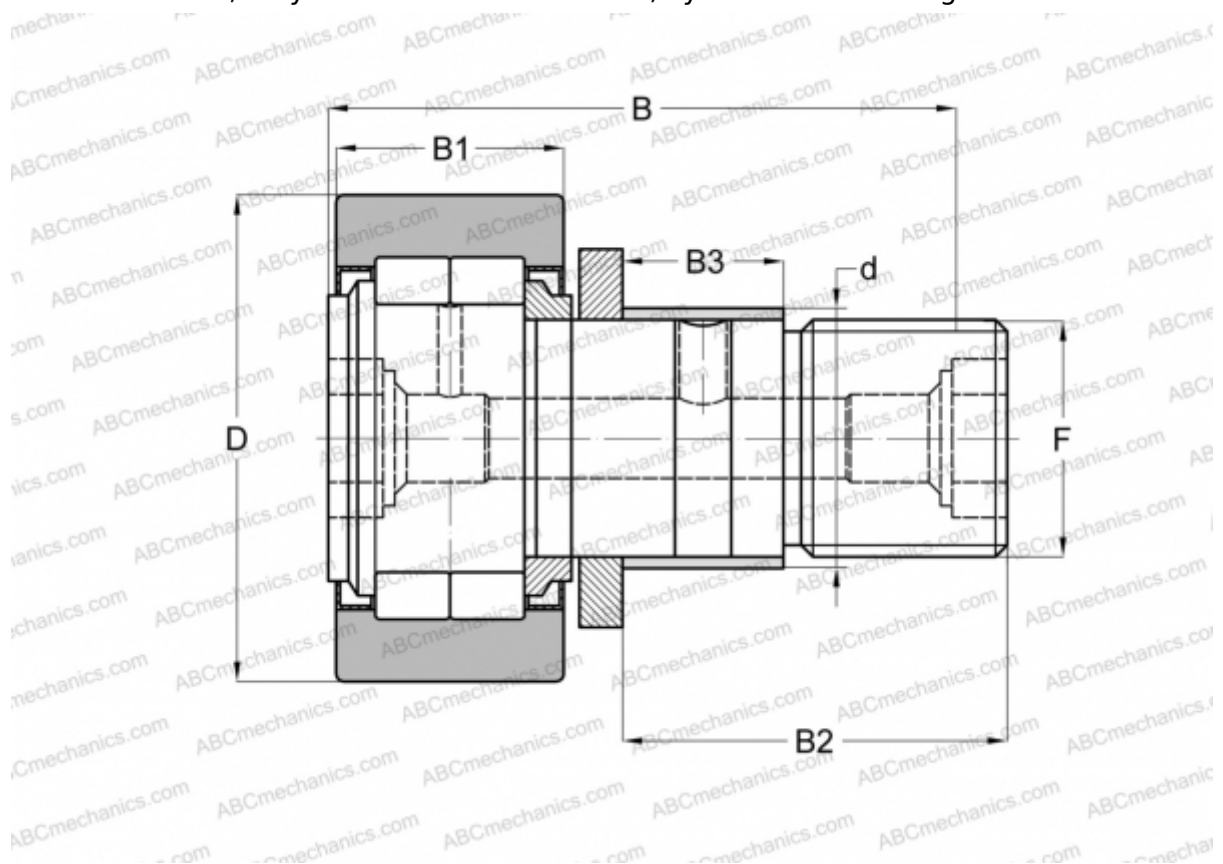

Technical specification

DIMENSIONS, MM

d	28,000
D	62,000
B	80,000
B1	29,000
B2	49,500
B3	22,000
F	M24x1,5

WEIGHT, KG 0,826

MANUFACTURER [INA](#)

INTERCHANGE

ABC	NUKRE 62 X
FAG	NUKRE 62 C DZ
SKF	NUKRE 62 X