

NUKRE 72 X INA

Cam followers

TYPE: Roller bearings, Stud type track rollers, With axial guidance, full complement cylindrical roller set, with eccentric collar, labyrinth seals on both sides, cylindrical outer ring

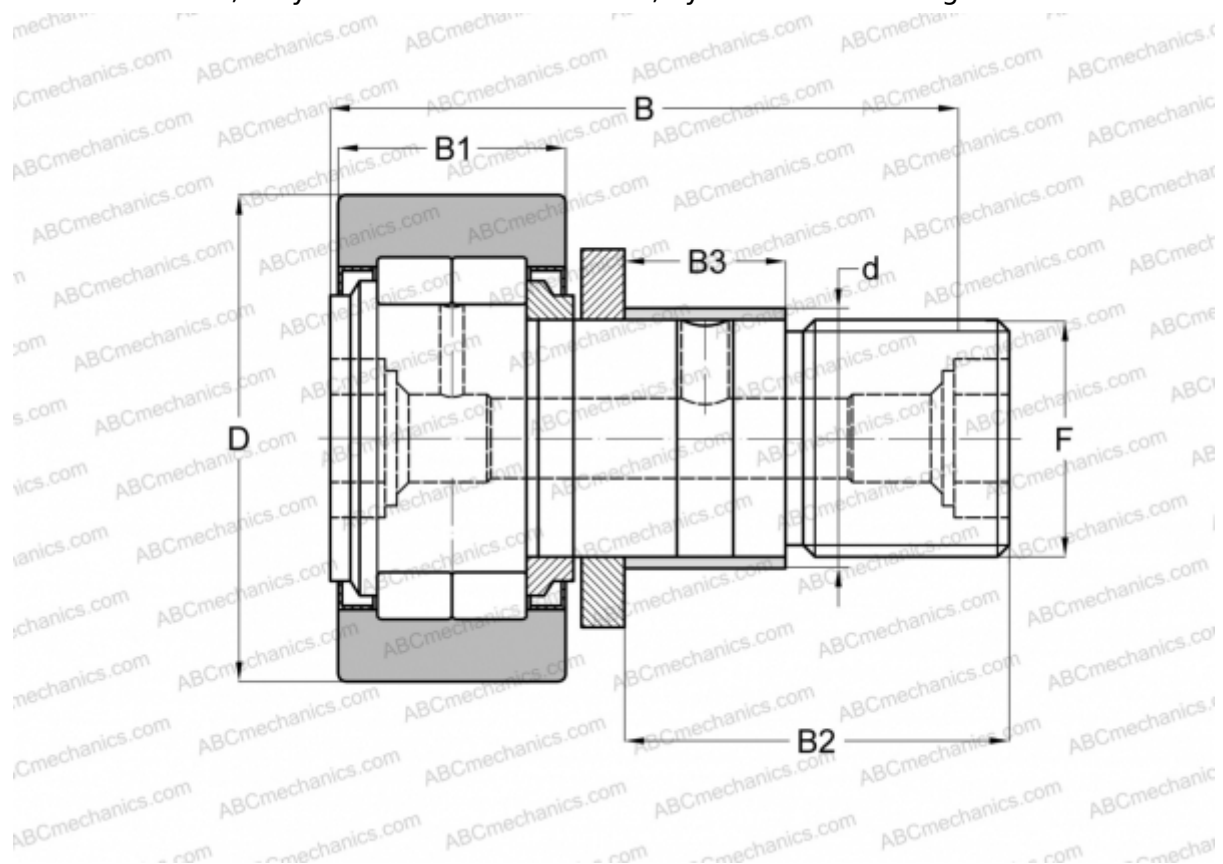

Technical specification

DIMENSIONS, MM

| | |
|----|---------|
| d | 28,000 |
| D | 72,000 |
| B | 80,000 |
| B1 | 29,000 |
| B2 | 49,500 |
| B3 | 22,000 |
| F | M24x1,5 |

WEIGHT, KG 1,039

MANUFACTURER [INA](#)

INTERCHANGE

| | |
|-----|-------------------------------|
| ABC | NUKRE 72 X |
| FAG | NUKRE 72 C DZ |
| SKF | NUKRE 72 X |