

NUKRE 72 X SKF

Cam followers

TYPE: Roller bearings, Stud type track rollers, With axial guidance, full complement cylindrical roller set, with eccentric collar, labyrinth seals on both sides, cylindrical outer ring

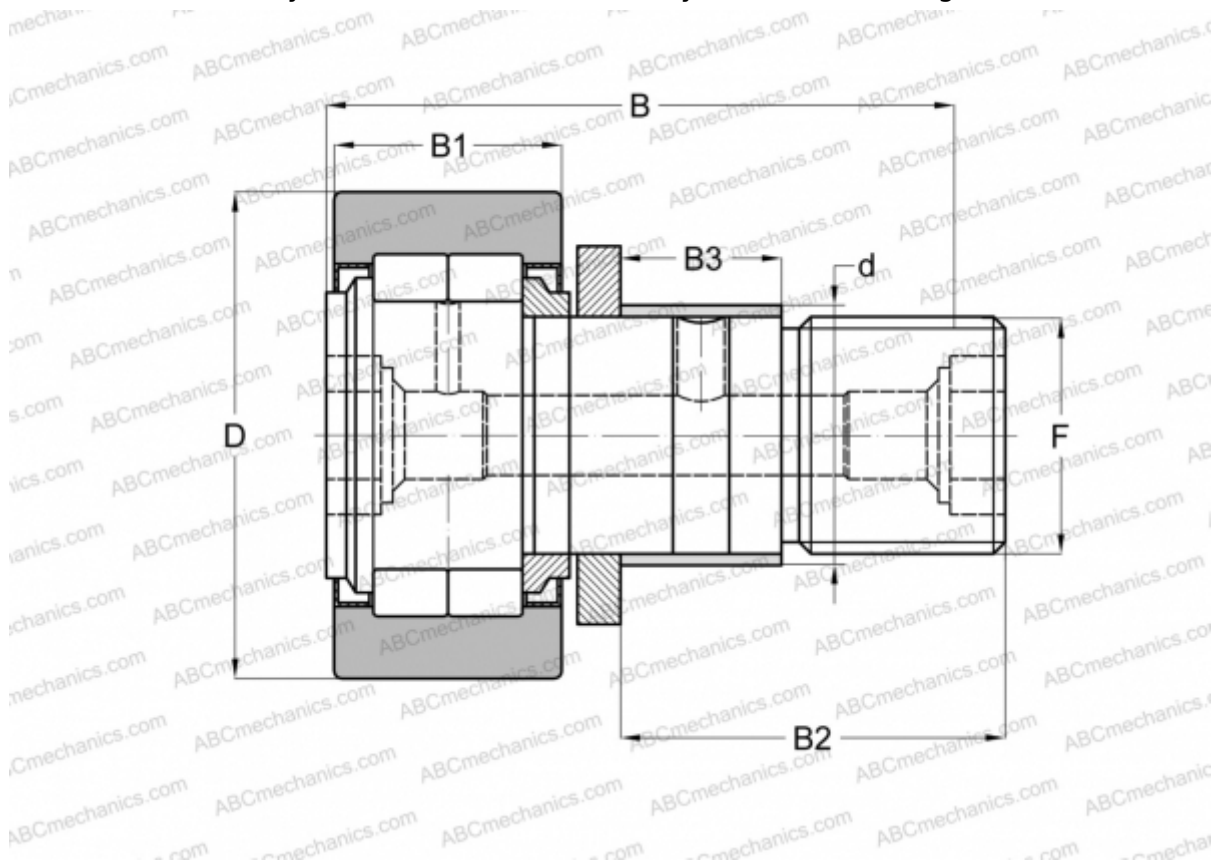

Technical specification

DIMENSIONS, MM

d	28,000
D	72,000
B	80,000
B1	28,000
B2	49,500
F	M 24x1.5

WEIGHT, KG 1,050

MANUFACTURER [SKF](#)

INTERCHANGE

ABC	NUKRE 72 X
FAG	NUKRE 72 C DZ
INA	NUKRE 72 X

CALCULATION DATA

Basic dynamic load rating, C	45,700 kN
Basic static load rating, Co	58,500 kN
Fatigue load limit, Pu	7,100 kN
Limiting speed	2000 r/min