

BMB-6202/032S2/UB108A SKF

Motor encoder units

TYPE: Ball bearings, Sensor bearing units, Motor encoder units (SKF)

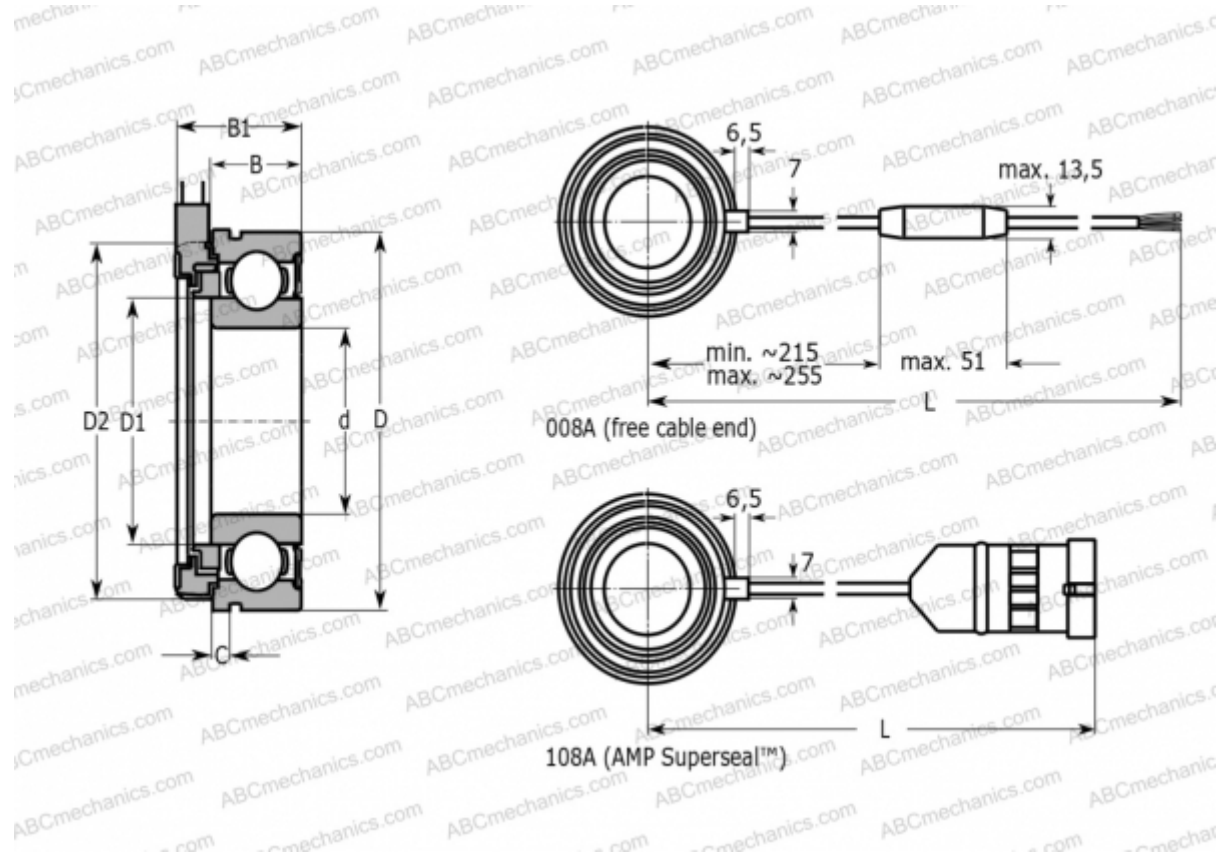

Technical specification

DIMENSIONS, MM

d	15,000
D	35,000
D1	19,500
D2	34,500
B	11,000
B1	17,200
L	550,000
C	2,060

MANUFACTURER

[SKF](#)

CALCULATION DATA

Basic dynamic load rating, C	7,800 kN
Basic static load rating, Co	3,750 kN
Fatigue load limit, Pu	0,160 kN
Limiting speed	14000 r/min