

BMO-6204/048S2/UA108A SKF

Motor encoder units

TYPE: Ball bearings, Sensor bearing units, Motor encoder units (SKF)

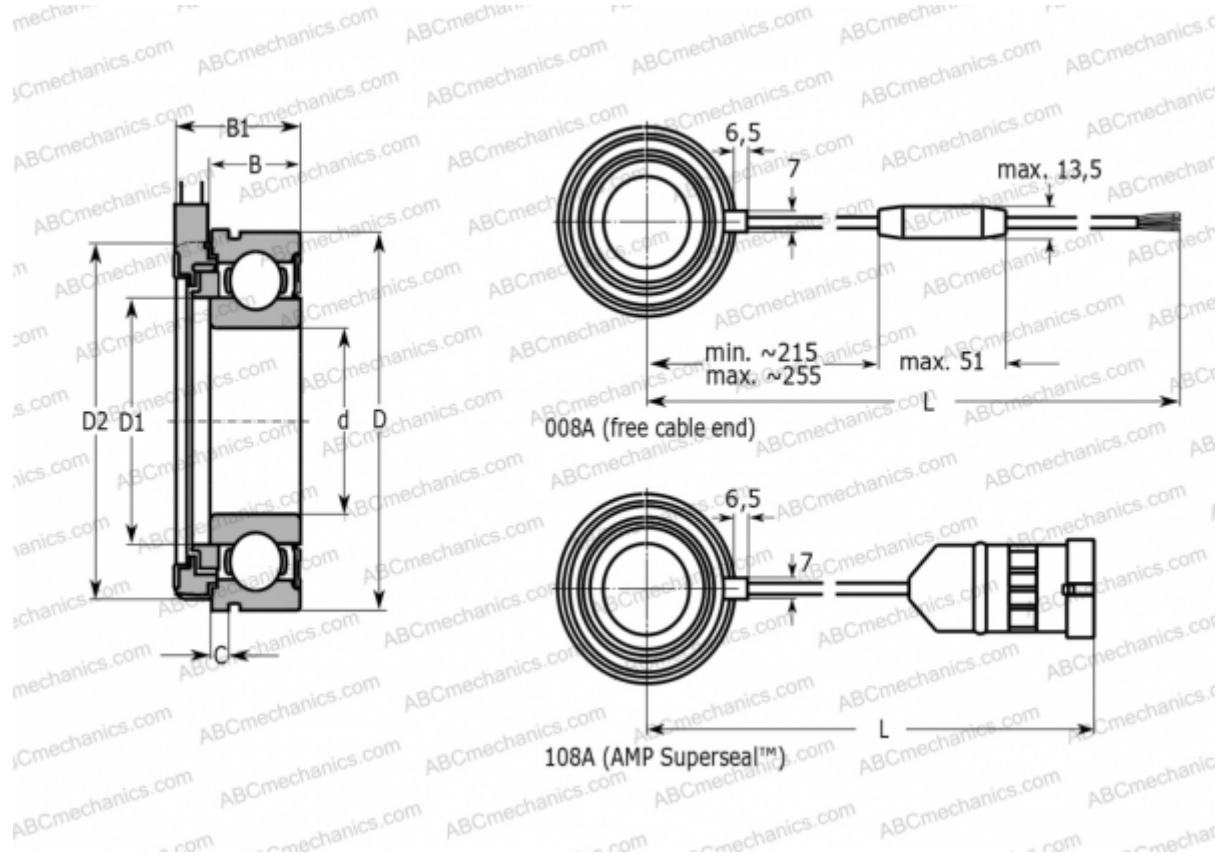

Technical specification

DIMENSIONS, MM

d	20,000
D	47,000
D1	28,690
D2	46,500
B	14,000
B1	20,200
L	560,000
C	2,460

MANUFACTURER

[SKF](#)

CALCULATION DATA

Basic dynamic load rating, C	12,700 kN
Basic static load rating, Co	6,550 kN
Fatigue load limit, Pu	0,280 kN
Limiting speed	10000 r/min