

BMO-6205/048S2/UA108A SKF

Motor encoder units

TYPE: Ball bearings, Sensor bearing units, Motor encoder units (SKF)

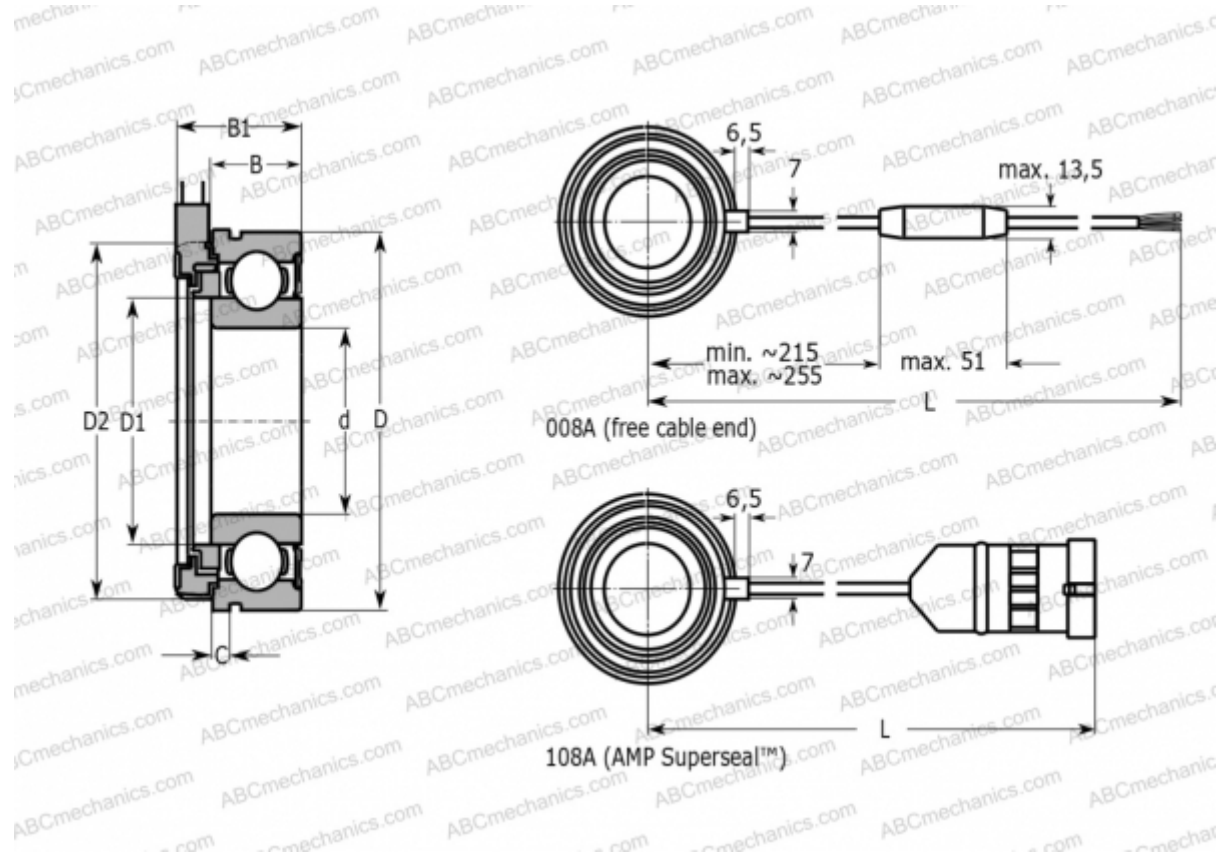

Technical specification

DIMENSIONS, MM

d	25,000
D	52,000
D1	31,600
D2	51,500
B	15,000
B1	21,200
L	560,000
C	2,460

MANUFACTURER

[SKF](#)

CALCULATION DATA

Basic dynamic load rating, C	14,000 kN
Basic static load rating, Co	7,800 kN
Fatigue load limit, Pu	0,335 kN
Limiting speed	8500 r/min