

BMO-6206/064S2/UA008A SKF

Motor encoder units

TYPE: Ball bearings, Sensor bearing units, Motor encoder units (SKF)

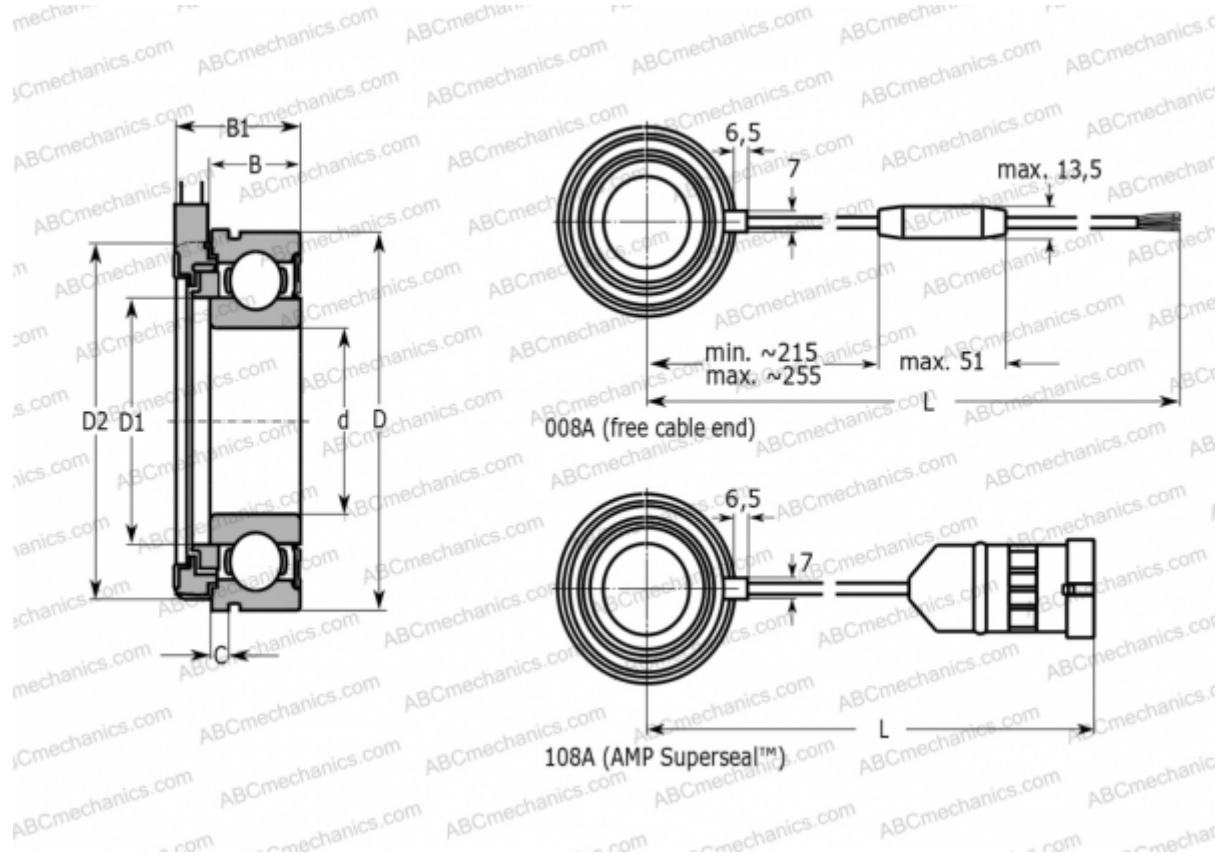

Technical specification

DIMENSIONS, MM

d	30,000
D	62,000
D1	40,250
D2	58,000
B	16,000
B1	22,200
L	540,000
C	3,280

MANUFACTURER

[SKF](#)

CALCULATION DATA

Basic dynamic load rating, C	19,500 kN
Basic static load rating, Co	11,200 kN
Fatigue load limit, Pu	0,475 kN
Limiting speed	7500 r/min