

BMB-6208/080S2/UB108A SKF

Motor encoder units

TYPE: Ball bearings, Sensor bearing units, Motor encoder units (SKF)

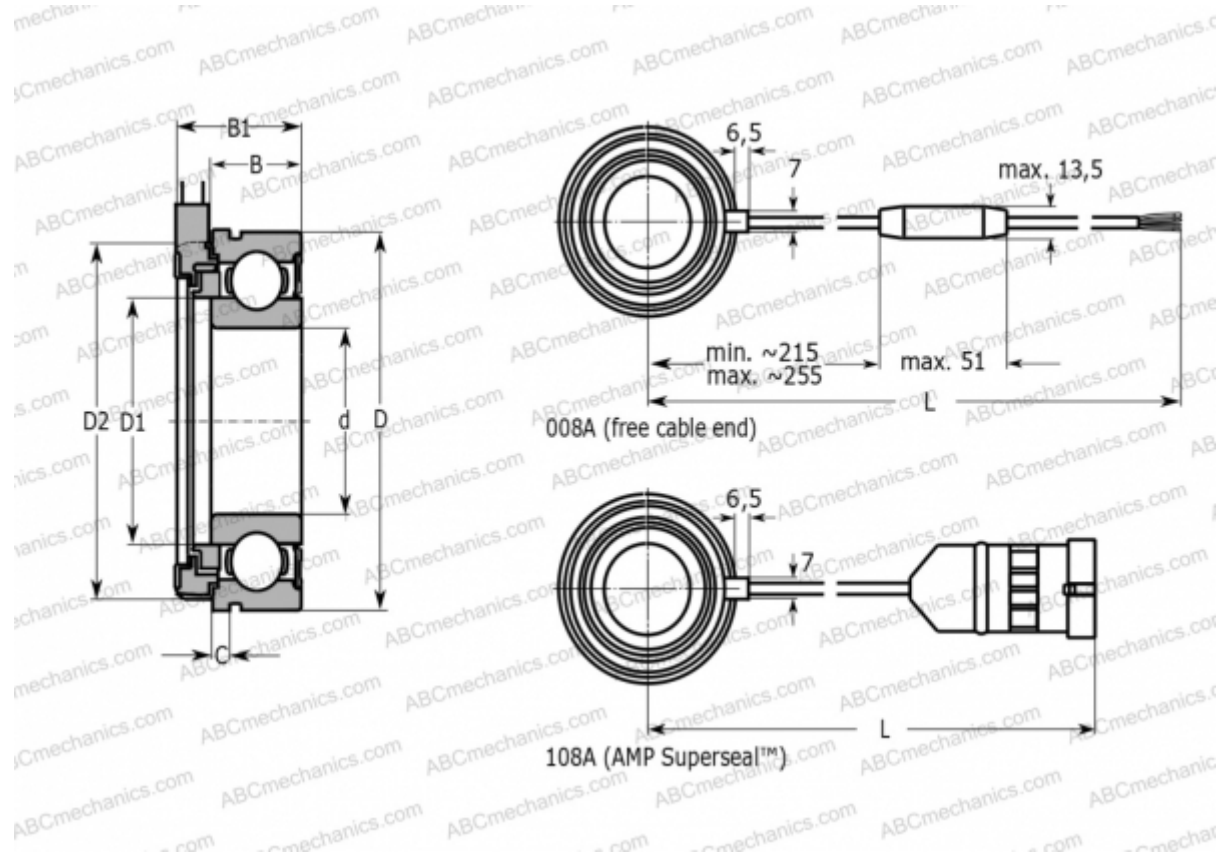

Technical specification

DIMENSIONS, MM

d	40,000
D	80,000
D1	47,900
D2	75,100
B	18,000
B1	24,200
L	570,000
C	3,280

MANUFACTURER

[SKF](#)

CALCULATION DATA

Basic dynamic load rating, C	30,700 kN
Basic static load rating, Co	19,000 kN
Fatigue load limit, Pu	0,800 kN
Limiting speed	5600 r/min