

51100 V/HR11T1 SKF

Thrust ball bearings

TYPE: Ball bearings, Thrust ball bearing, Single direction, Polymer, stainless steel ball (SKF)

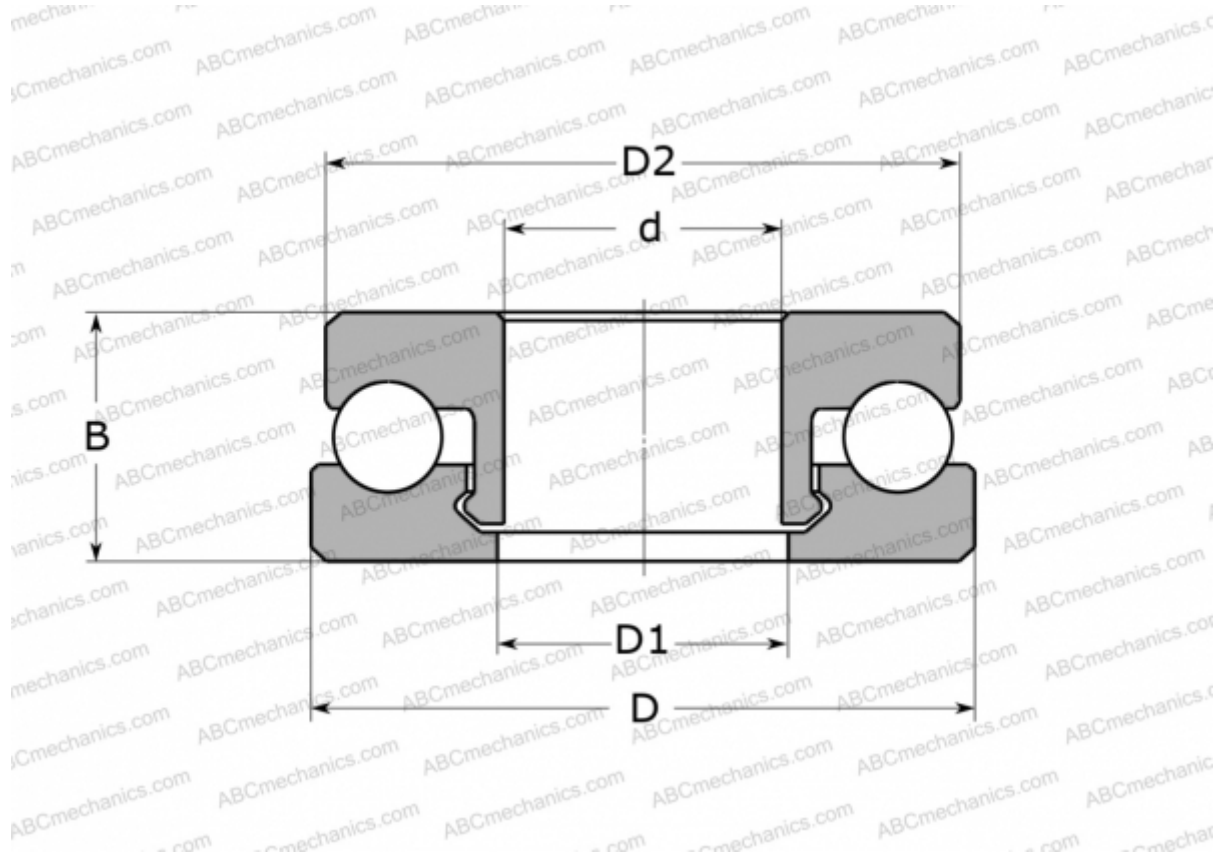

Technical specification

DIMENSIONS, MM

d	10,000
D	24,000
D1	11,000
D2	23,000
B	9,000

WEIGHT, KG 5,200

MANUFACTURER [SKF](#)

CALCULATION DATA

Basic dynamic load rating, C	0,250 kN
Basic static load rating, Co	0,200 kN
Limiting speed	600 r/min