

51101 V/HR11T1 SKF

Thrust ball bearings

TYPE: Ball bearings, Thrust ball bearing, Single direction, Polymer, stainless steel ball (SKF)

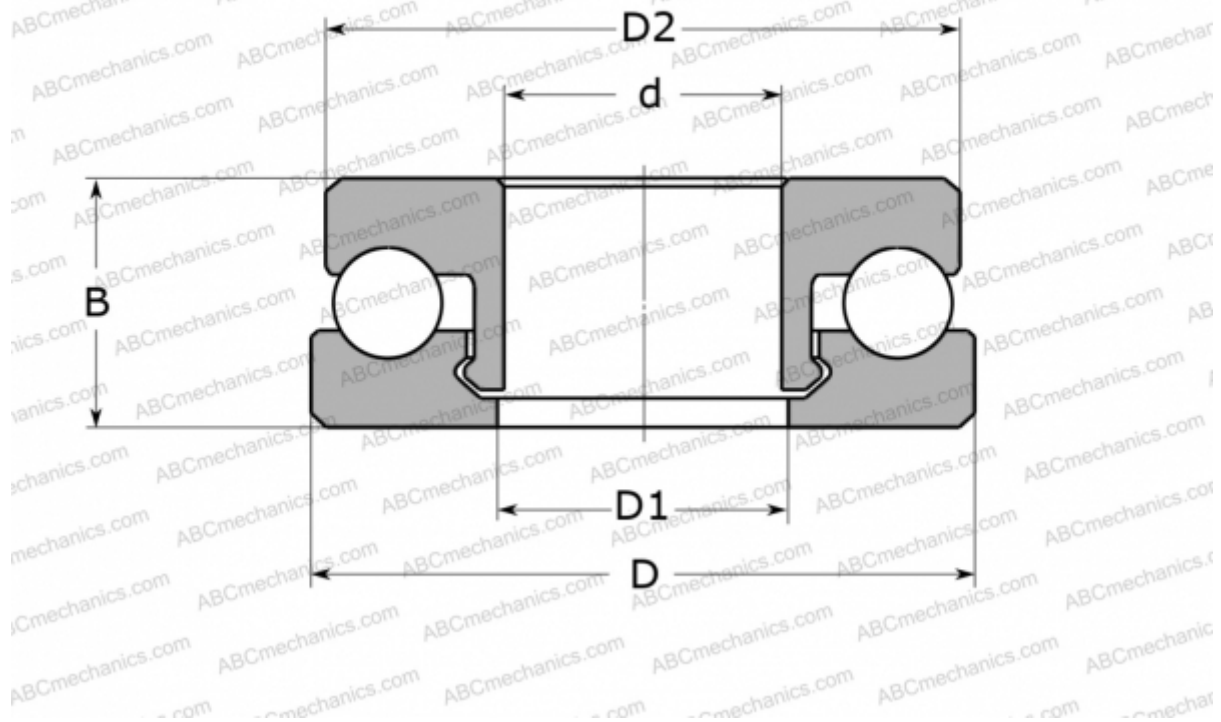

Technical specification

DIMENSIONS, MM

d	12,000
D	26,000
D1	13,000
D2	25,000
B	9,000

WEIGHT, KG 5,600

MANUFACTURER [SKF](#)

CALCULATION DATA

Basic dynamic load rating, C	0,400 kN
Basic static load rating, Co	0,320 kN
Limiting speed	540 r/min