

51102 V/HR11T1 SKF

Thrust ball bearings

TYPE: Ball bearings, Thrust ball bearing, Single direction, Polymer, stainless steel ball (SKF)

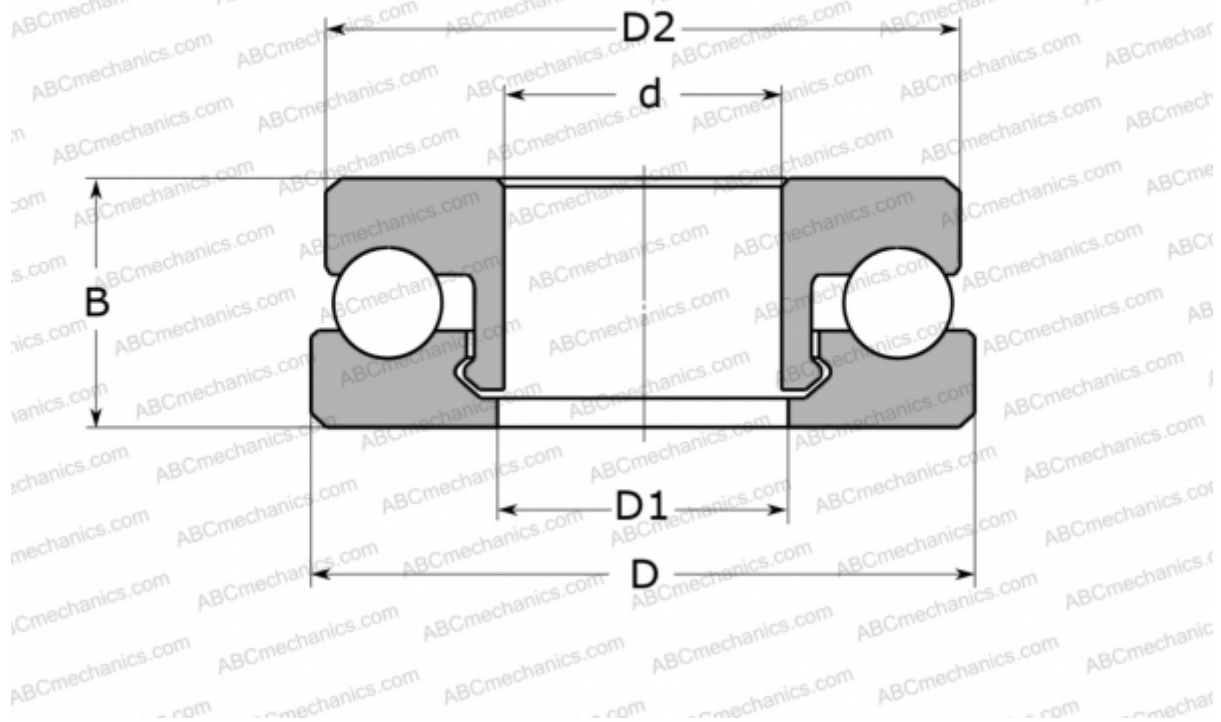

Technical specification

DIMENSIONS, MM

d	15,000
D	28,000
D1	16,000
D2	27,000
B	9,000

WEIGHT, KG 6,100

MANUFACTURER [SKF](#)

CALCULATION DATA

Basic dynamic load rating, C	0,625 kN
Basic static load rating, Co	0,500 kN
Limiting speed	500 r/min