

## 51102 V/HR22T2 SKF

Thrust ball bearings

TYPE: Ball bearings, Thrust ball bearing, Single direction, Polymer, stainless steel ball (SKF)

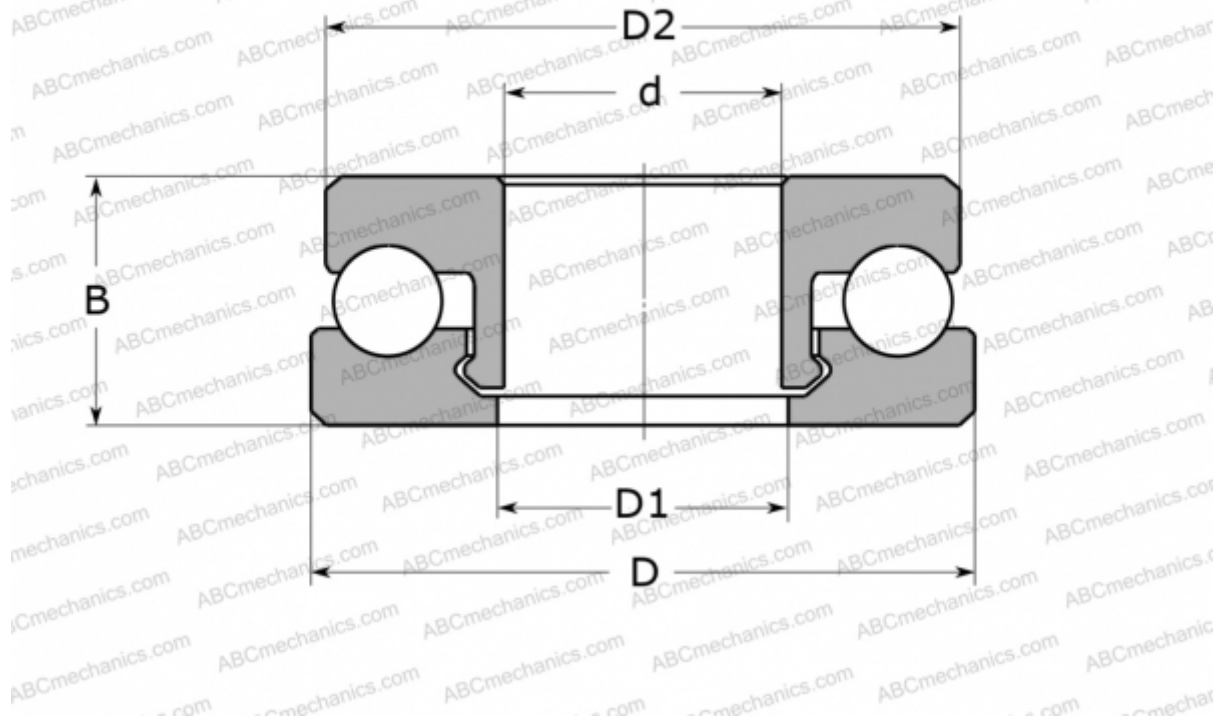

### Technical specification

#### DIMENSIONS, MM

d	15,000
D	28,000
D1	16,000
D2	27,000
B	9,000

**WEIGHT, KG** 4,700

**MANUFACTURER** [SKF](#)

#### CALCULATION DATA

Basic dynamic load rating, C	0,550 kN
Basic static load rating, Co	0,440 kN
Limiting speed	460 r/min