

51103 V/HR22T2 SKF

Thrust ball bearings

TYPE: Ball bearings, Thrust ball bearing, Single direction, Polymer, stainless steel ball (SKF)

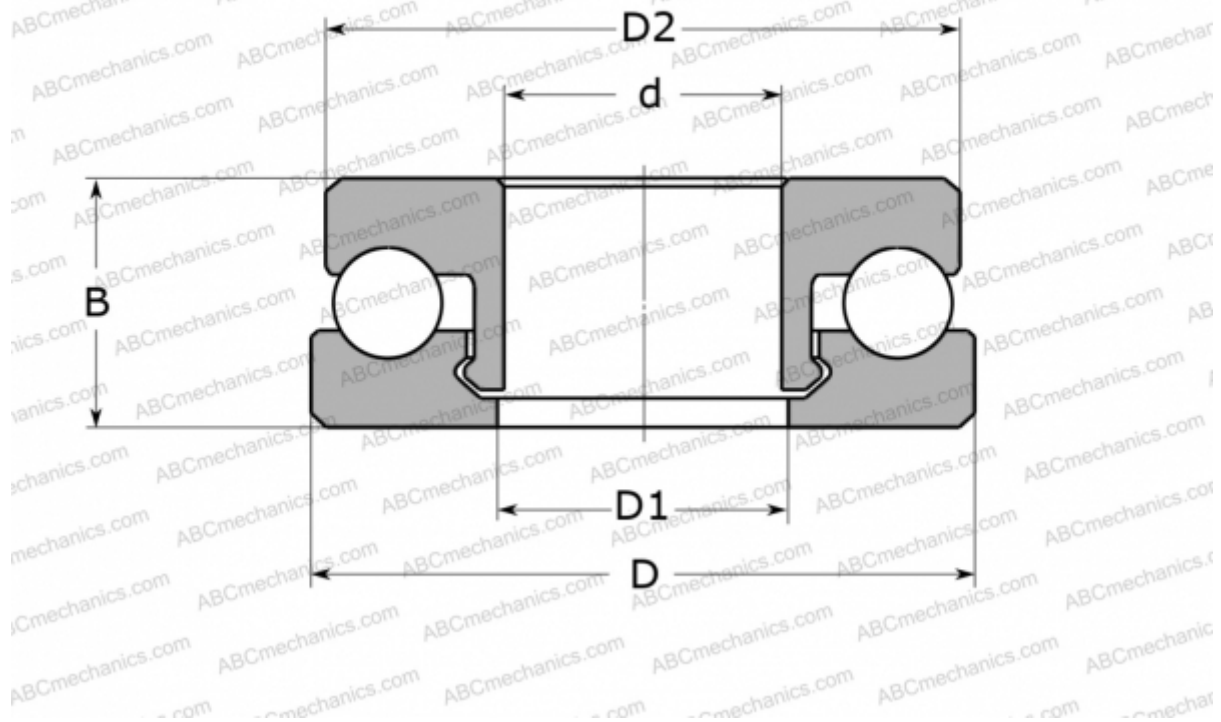

Technical specification

DIMENSIONS, MM

d	17,000
D	30,000
D1	18,000
D2	29,000
B	9,000

WEIGHT, KG 5,400

MANUFACTURER [SKF](#)

CALCULATION DATA

Basic dynamic load rating, C	0,625 kN
Basic static load rating, Co	0,500 kN
Limiting speed	440 r/min