

51203 V/HR22T2 SKF

Thrust ball bearings

TYPE: Ball bearings, Thrust ball bearing, Single direction, Polymer, stainless steel ball (SKF)

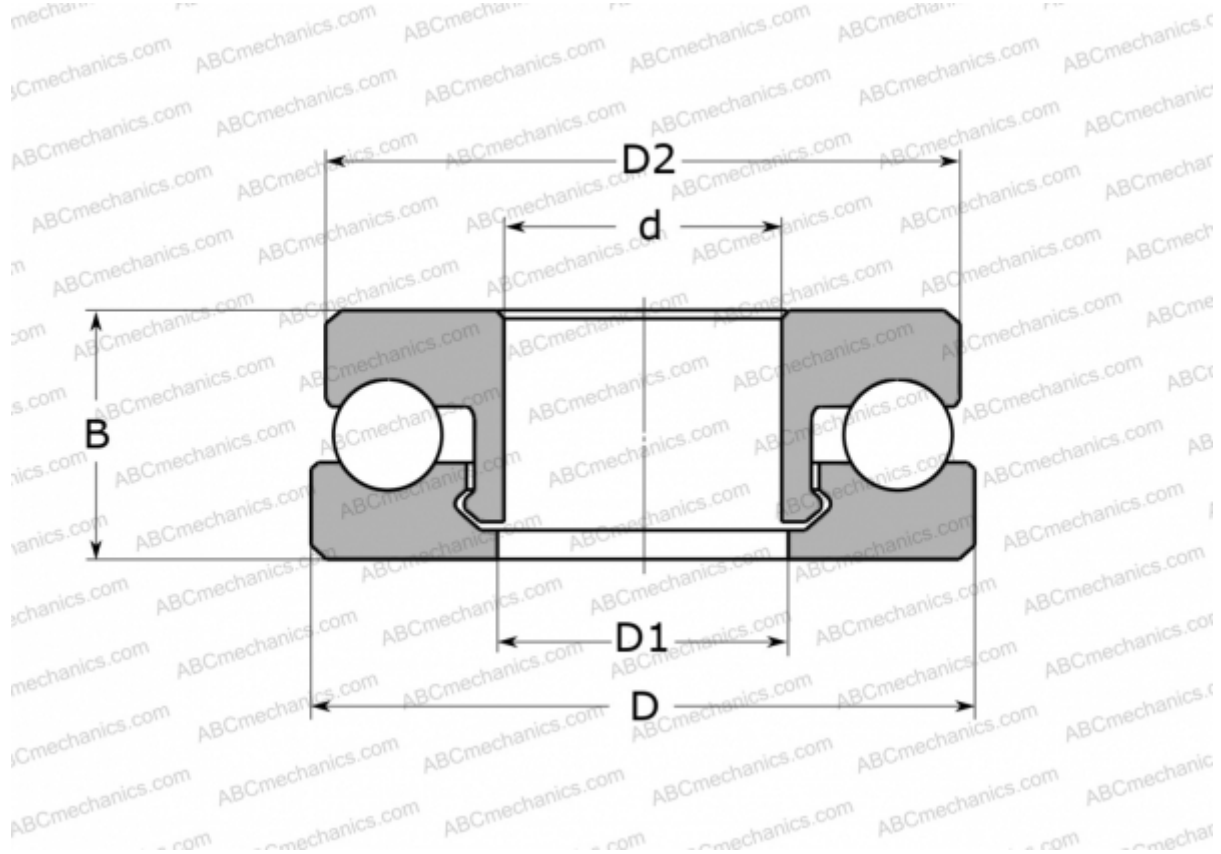

Technical specification

DIMENSIONS, MM

d	17,000
D	35,000
D1	18,000
D2	34,000
B	12,000

WEIGHT, KG 12,000

MANUFACTURER [SKF](#)

CALCULATION DATA

Basic dynamic load rating, C	0,660 kN
Basic static load rating, Co	0,530 kN
Limiting speed	440 r/min