

## 51104 V/HR22T2 SKF

Thrust ball bearings

TYPE: Ball bearings, Thrust ball bearing, Single direction, Polymer, stainless steel ball (SKF)

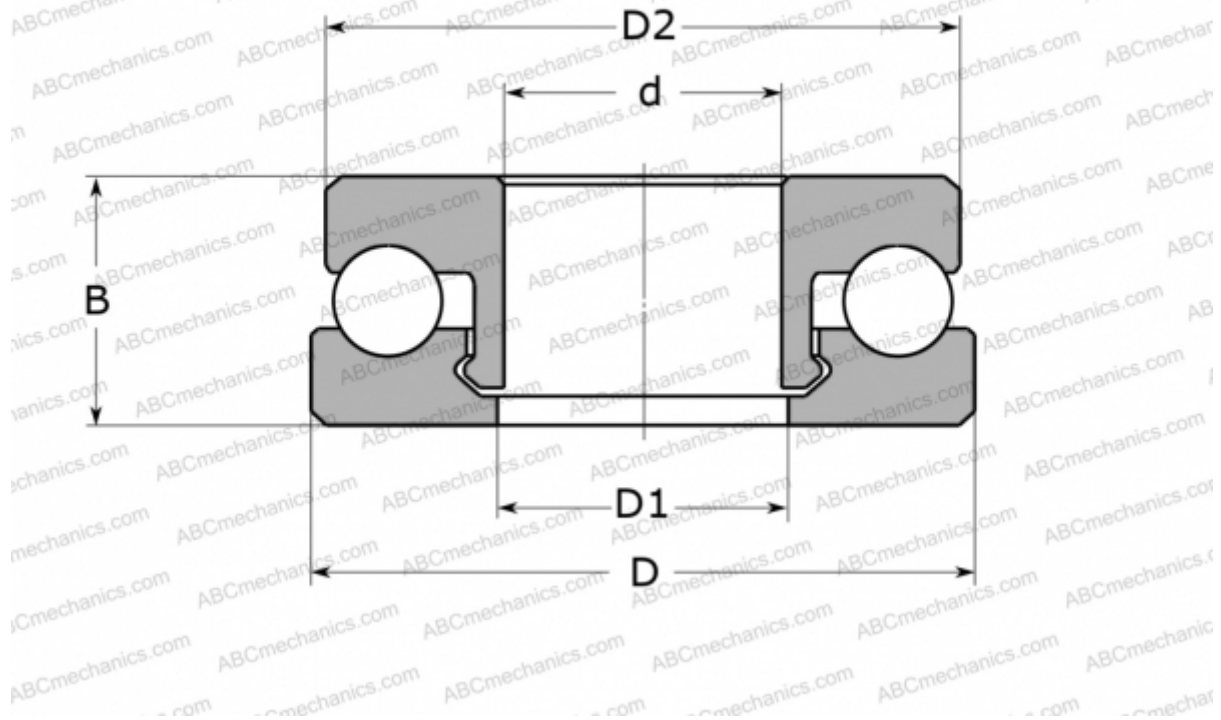

### Technical specification

#### DIMENSIONS, MM

d	20,000
D	35,000
D1	21,000
D2	34,000
B	10,000

**WEIGHT, KG** 8,100

**MANUFACTURER** [SKF](#)

#### CALCULATION DATA

Basic dynamic load rating, C	0,710 kN
Basic static load rating, Co	0,570 kN
Limiting speed	420 r/min