

51204 V/HR11T1 SKF

Thrust ball bearings

TYPE: Ball bearings, Thrust ball bearing, Single direction, Polymer, stainless steel ball (SKF)

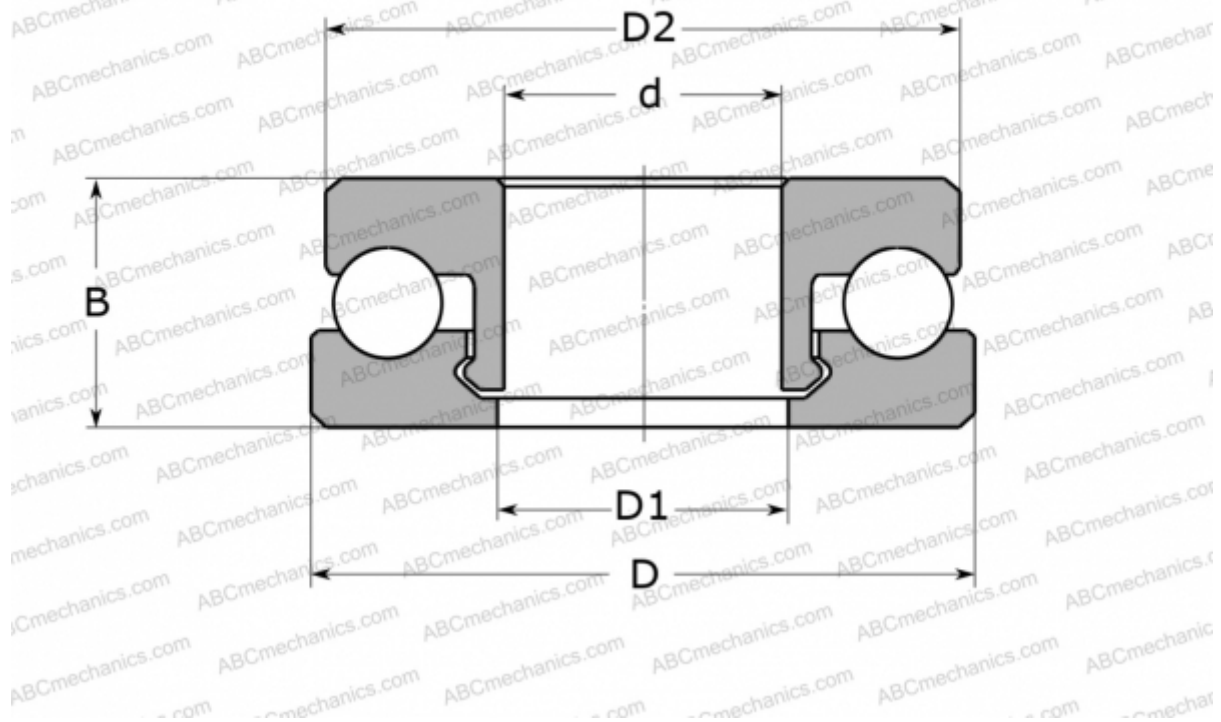

Technical specification

DIMENSIONS, MM

d	20,000
D	40,000
D1	21,000
D2	39,000
B	14,000

WEIGHT, KG 20,500

MANUFACTURER [SKF](#)

CALCULATION DATA

Basic dynamic load rating, C	0,860 kN
Basic static load rating, Co	0,690 kN
Limiting speed	460 r/min