

## 51204 V/HR22T2 SKF

Thrust ball bearings

TYPE: Ball bearings, Thrust ball bearing, Single direction, Polymer, stainless steel ball (SKF)

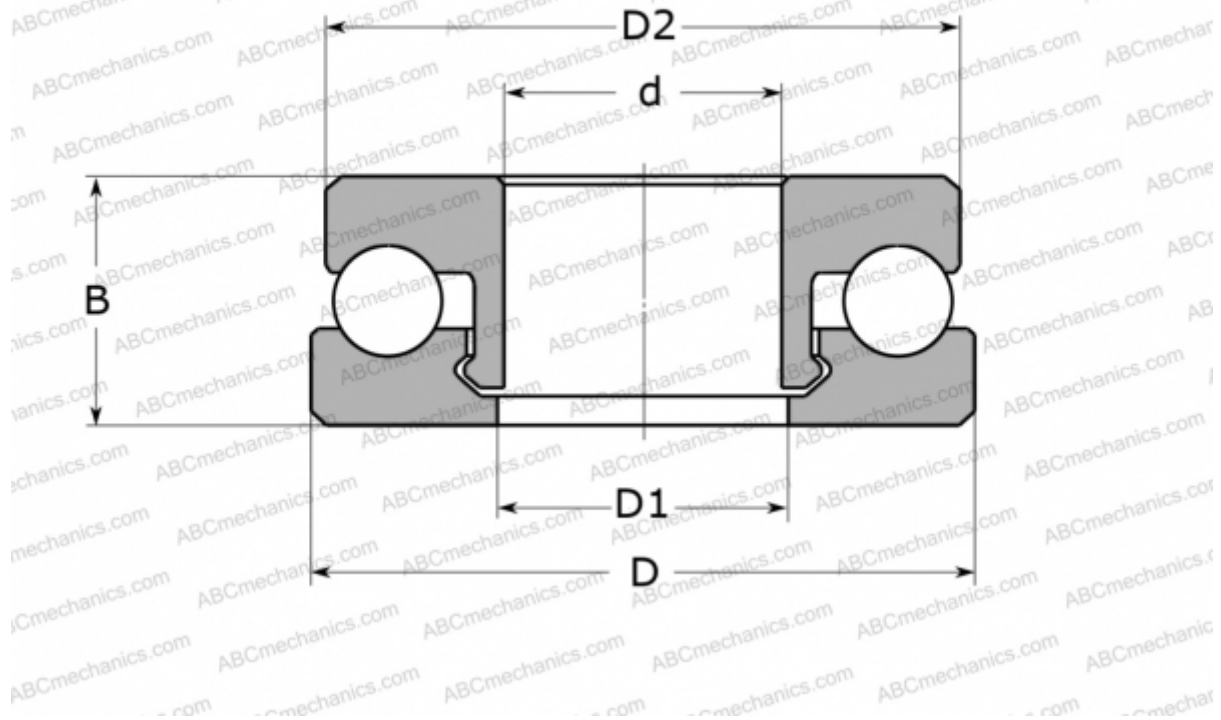

### Technical specification

#### DIMENSIONS, MM

d	20,000
D	40,000
D1	21,000
D2	39,000
B	14,000

**WEIGHT, KG** 16,000

**MANUFACTURER** [SKF](#)

#### CALCULATION DATA

Basic dynamic load rating, C	0,750 kN
Basic static load rating, Co	0,600 kN
Limiting speed	420 r/min