

## 51105 V/HR11T1 SKF

Thrust ball bearings

TYPE: Ball bearings, Thrust ball bearing, Single direction, Polymer, stainless steel ball (SKF)

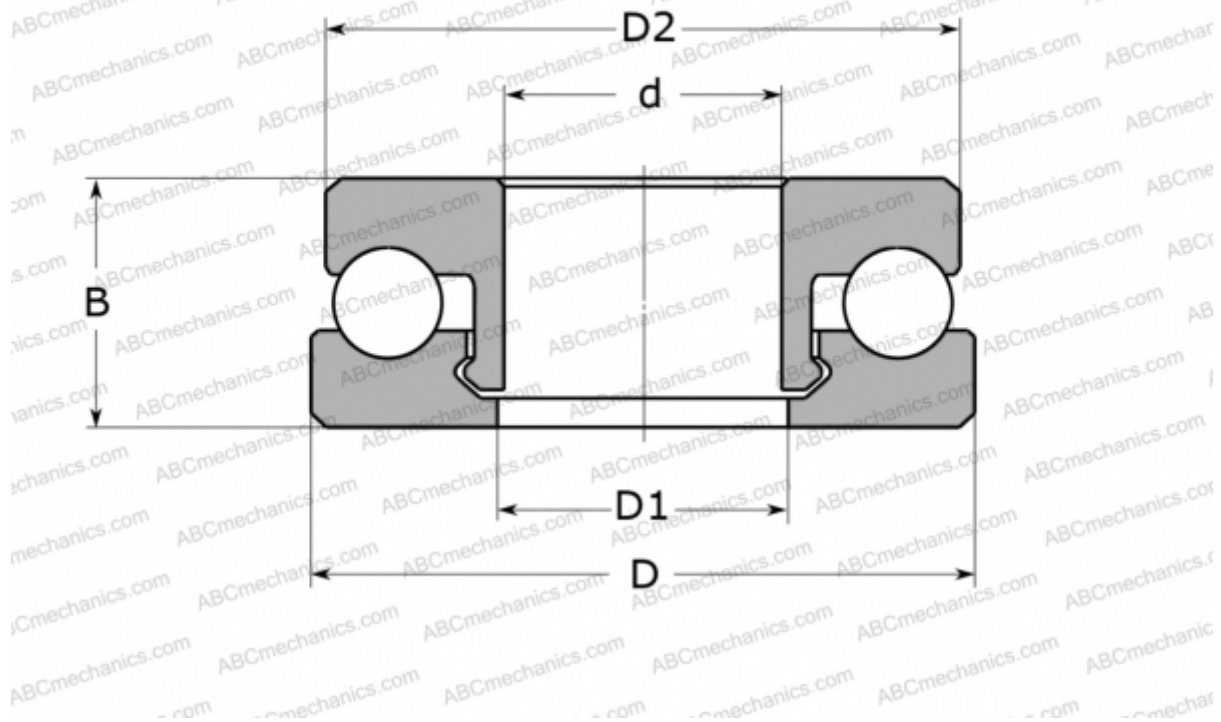

### Technical specification

#### DIMENSIONS, MM

d	25,000
D	42,000
D1	26,000
D2	41,000
B	11,000

**WEIGHT, KG** 14,500

**MANUFACTURER** [SKF](#)

#### CALCULATION DATA

Basic dynamic load rating, C	0,880 kN
Basic static load rating, Co	0,710 kN
Limiting speed	410 r/min