

51105 V/HR22T2 SKF

Thrust ball bearings

TYPE: Ball bearings, Thrust ball bearing, Single direction, Polymer, stainless steel ball (SKF)

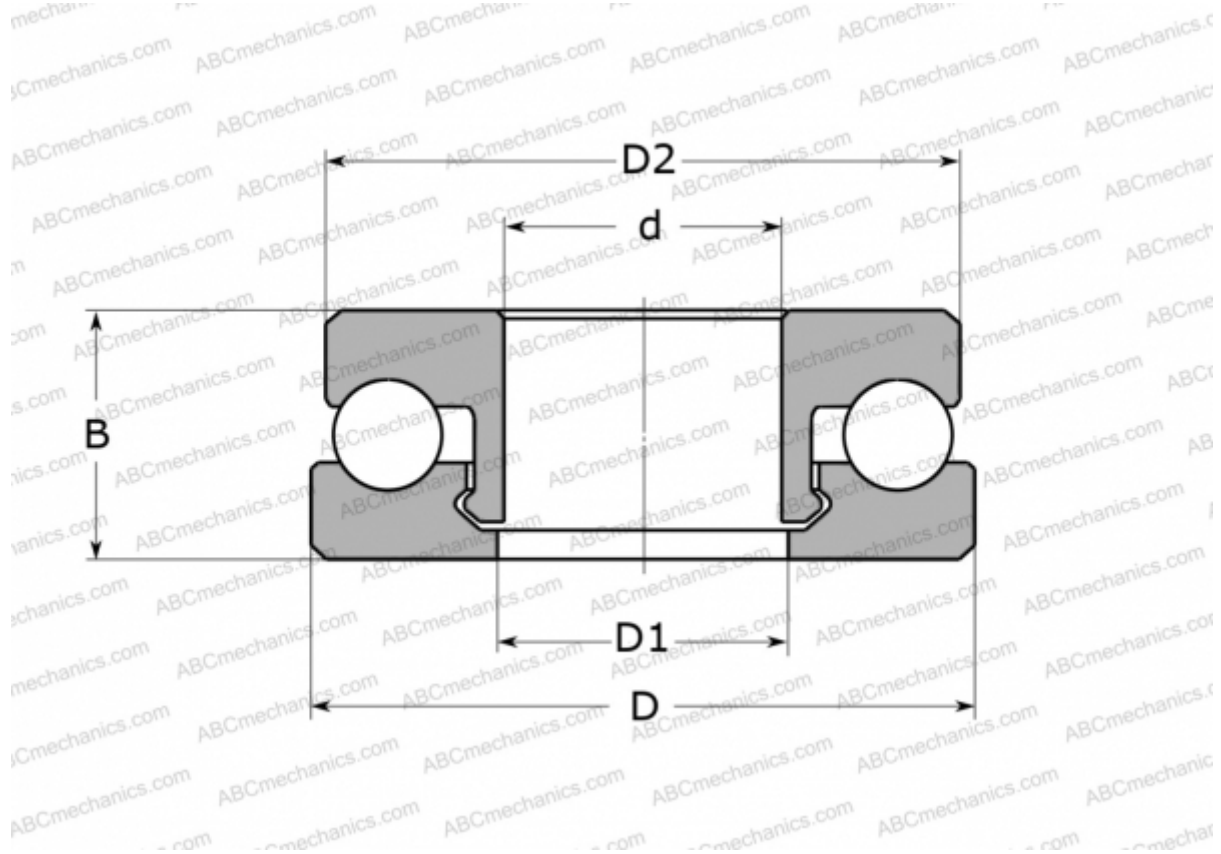

Technical specification

DIMENSIONS, MM

d	25,000
D	42,000
D1	26,000
D2	41,000
B	11,000

WEIGHT, KG 7,900

MANUFACTURER [SKF](#)

CALCULATION DATA

Basic dynamic load rating, C	0,770 kN
Basic static load rating, Co	0,625 kN
Limiting speed	375 r/min