

51106 V/HR11T1 SKF

Thrust ball bearings

TYPE: Ball bearings, Thrust ball bearing, Single direction, Polymer, stainless steel ball (SKF)

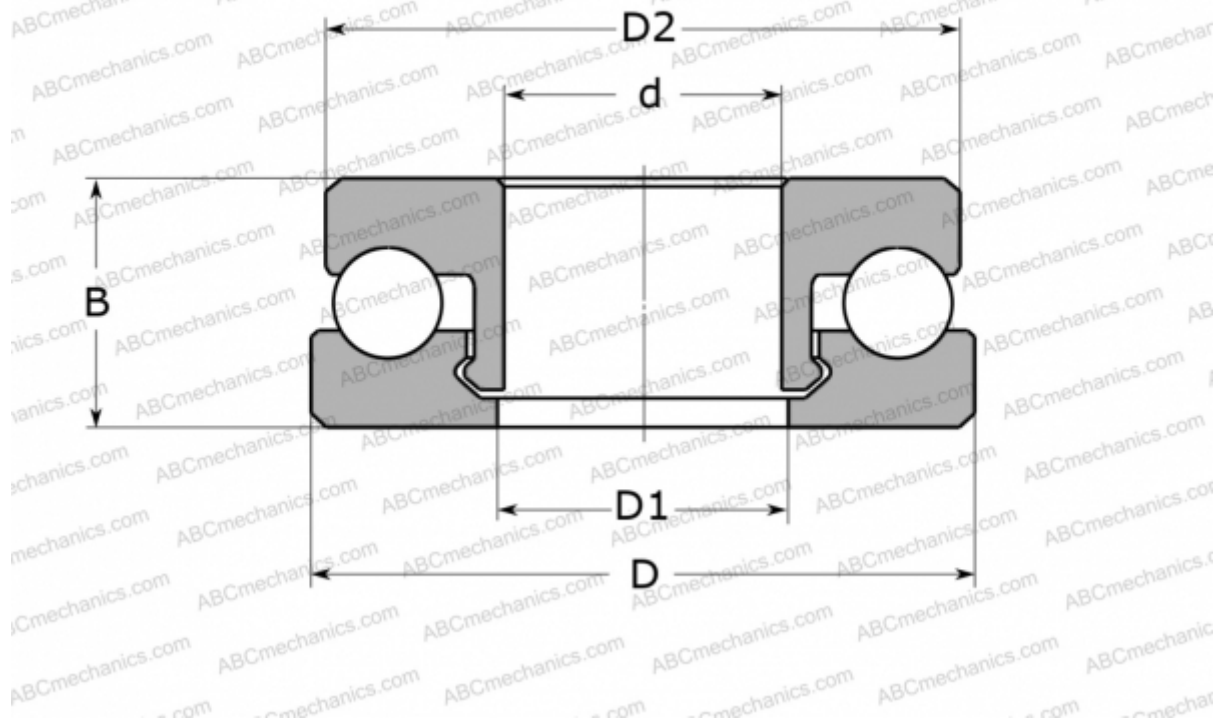

Technical specification

DIMENSIONS, MM

d	30,000
D	47,000
D1	31,000
D2	46,000
B	11,000

WEIGHT, KG 17,500

MANUFACTURER [SKF](#)

CALCULATION DATA

Basic dynamic load rating, C	0,950 kN
Basic static load rating, Co	0,760 kN
Limiting speed	400 r/min