

## 51106 V/HR22T2 SKF

Thrust ball bearings

TYPE: Ball bearings, Thrust ball bearing, Single direction, Polymer, stainless steel ball (SKF)

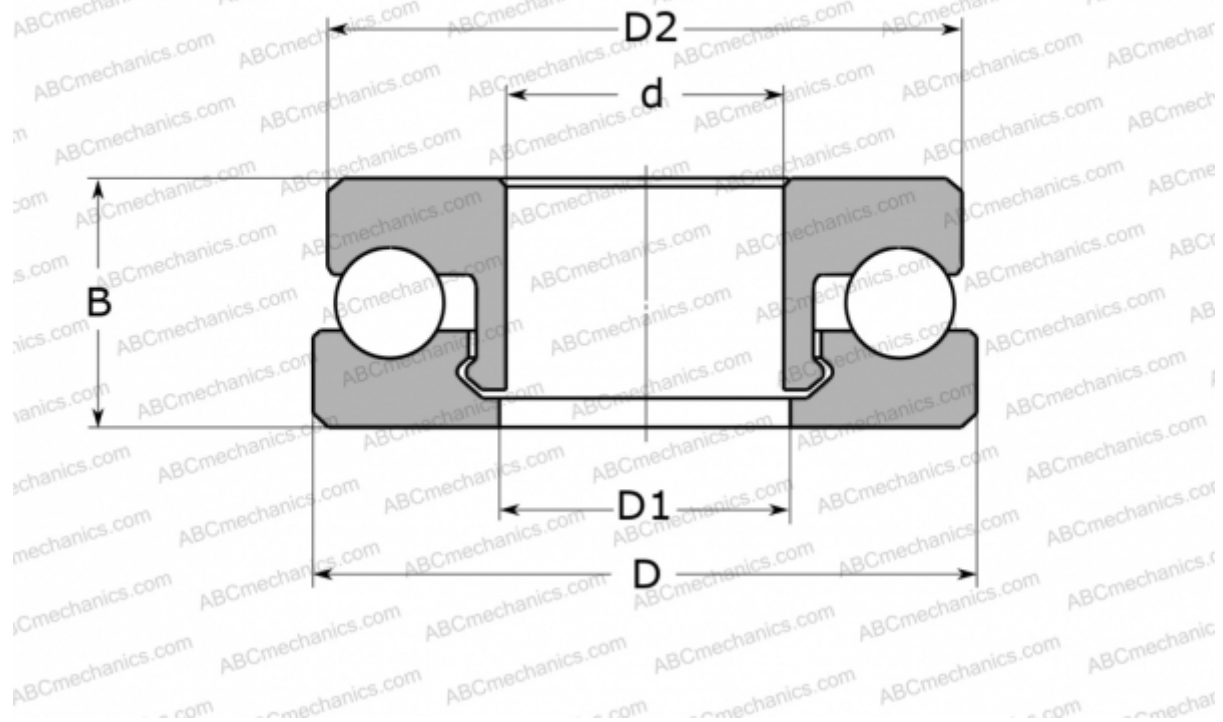

### Technical specification

#### DIMENSIONS, MM

d	30,000
D	47,000
D1	31,000
D2	46,000
B	11,000

**WEIGHT, KG** 13,000

**MANUFACTURER** [SKF](#)

#### CALCULATION DATA

Basic dynamic load rating, C	0,835 kN
Basic static load rating, Co	0,670 kN
Limiting speed	370 r/min