

51206 V/HR22T2 SKF

Thrust ball bearings

TYPE: Ball bearings, Thrust ball bearing, Single direction, Polymer, stainless steel ball (SKF)

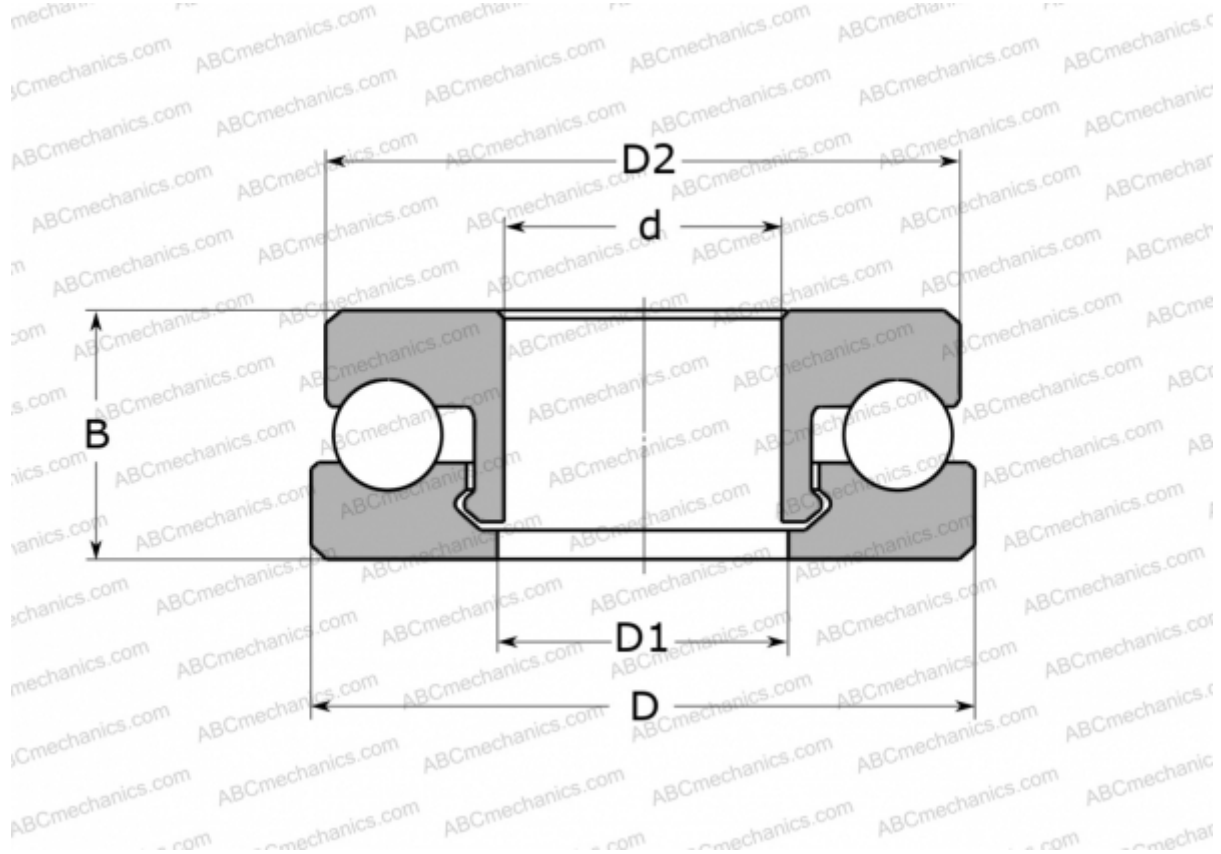

Technical specification

DIMENSIONS, MM

d	30,000
D	52,000
D1	31,000
D2	51,000
B	16,000

WEIGHT, KG 25,500

MANUFACTURER [SKF](#)

CALCULATION DATA

Basic dynamic load rating, C	0,900 kN
Basic static load rating, Co	0,720 kN
Limiting speed	345 r/min