

51306 V/HR11T1 SKF

Thrust ball bearings

TYPE: Ball bearings, Thrust ball bearing, Single direction, Polymer, stainless steel ball (SKF)

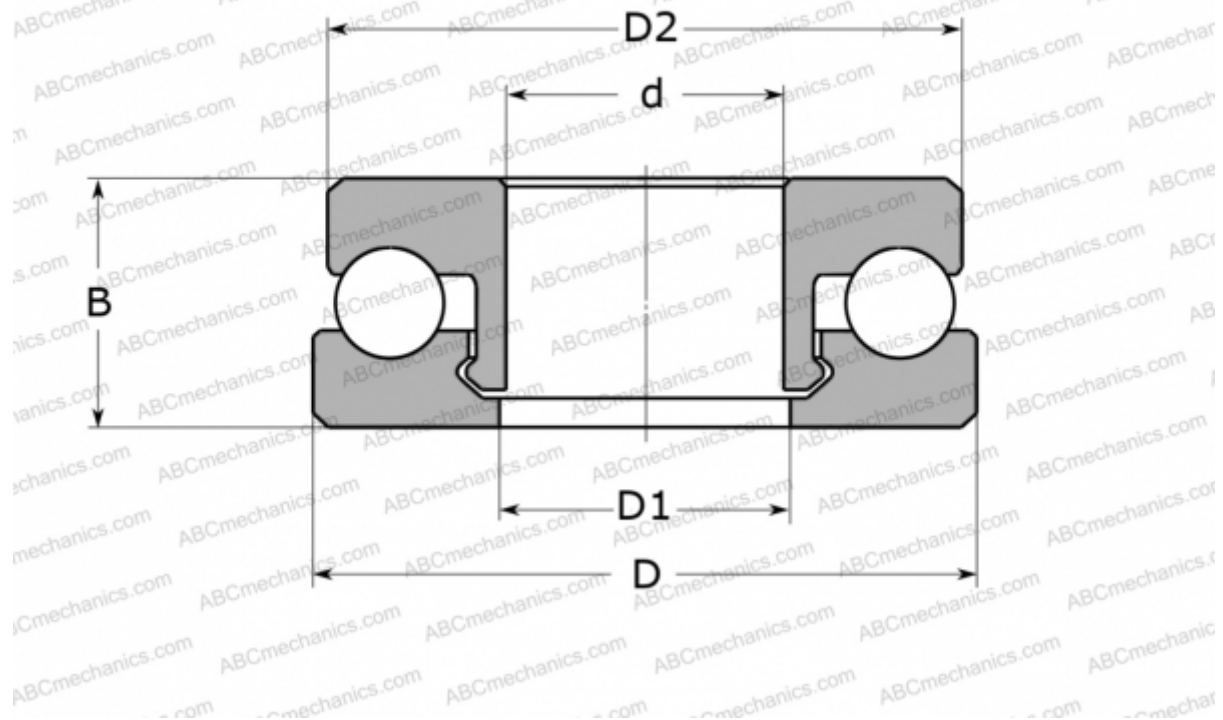

Technical specification

DIMENSIONS, MM

| | |
|----|--------|
| d | 30,000 |
| D | 60,000 |
| D1 | 31,000 |
| D2 | 59,000 |
| B | 21,000 |

WEIGHT, KG 63,000

MANUFACTURER [SKF](#)

CALCULATION DATA

| | |
|------------------------------|-----------|
| Basic dynamic load rating, C | 1,070 kN |
| Basic static load rating, Co | 0,860 kN |
| Limiting speed | 360 r/min |