

51107 V/HR11T1 SKF

Thrust ball bearings

TYPE: Ball bearings, Thrust ball bearing, Single direction, Polymer, stainless steel ball (SKF)

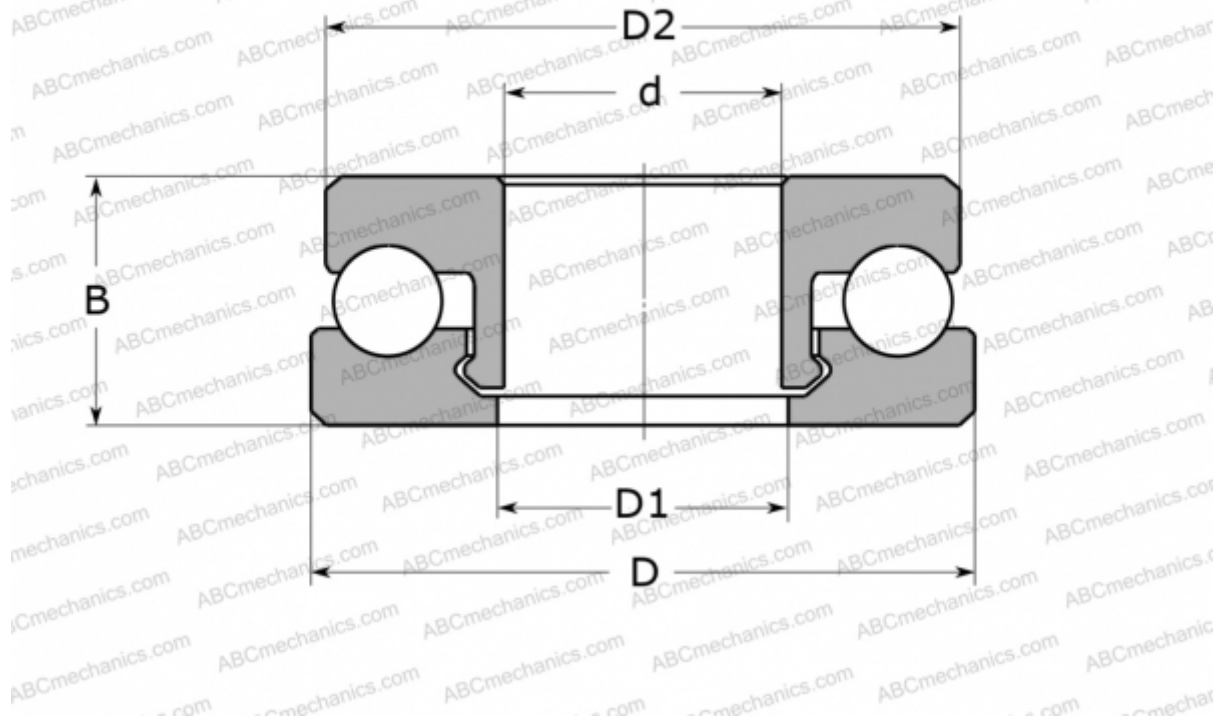

Technical specification

DIMENSIONS, MM

d	35,000
D	52,000
D1	36,000
D2	51,000
B	12,000

WEIGHT, KG 21,000

MANUFACTURER [SKF](#)

CALCULATION DATA

Basic dynamic load rating, C	1,010 kN
Basic static load rating, Co	0,810 kN
Limiting speed	390 r/min