

## 51107 V/HR22T2 SKF

Thrust ball bearings

TYPE: Ball bearings, Thrust ball bearing, Single direction, Polymer, stainless steel ball (SKF)

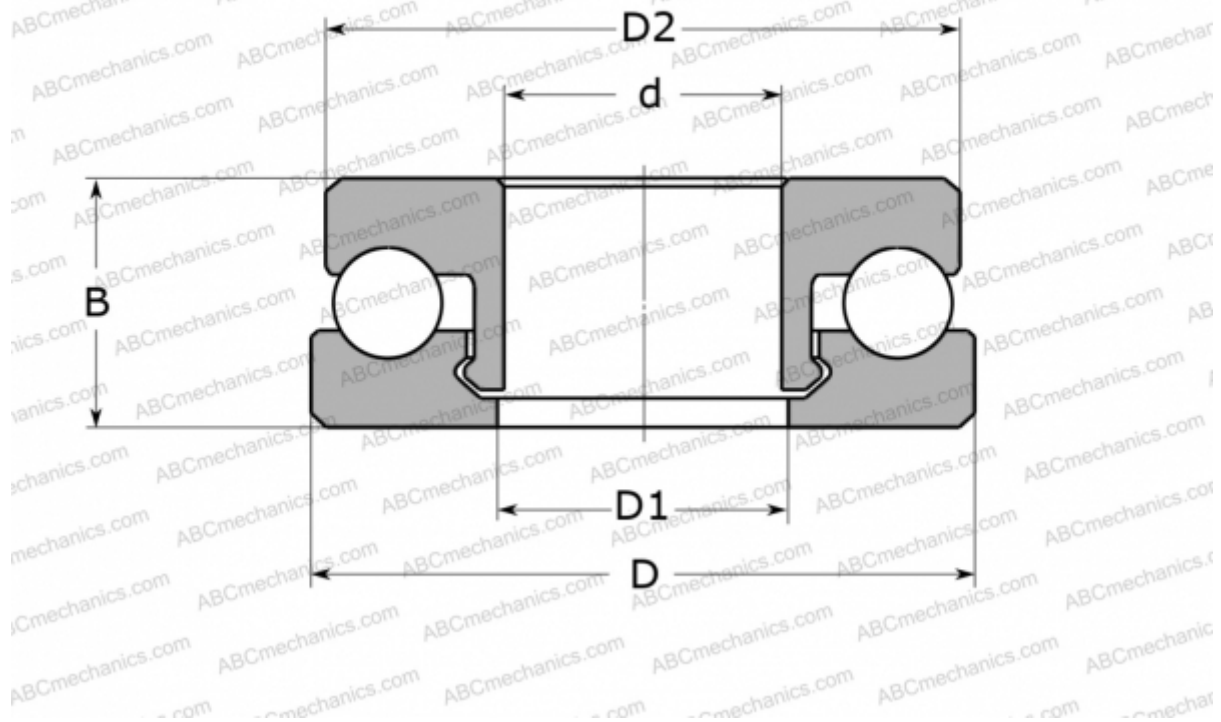

### Technical specification

#### DIMENSIONS, MM

d	35,000
D	52,000
D1	36,000
D2	51,000
B	12,000

**WEIGHT, KG** 15,500

**MANUFACTURER** [SKF](#)

#### CALCULATION DATA

Basic dynamic load rating, C	0,885 kN
Basic static load rating, Co	0,710 kN
Limiting speed	360 r/min