

51207 V/HR22T2 SKF

Thrust ball bearings

TYPE: Ball bearings, Thrust ball bearing, Single direction, Polymer, stainless steel ball (SKF)

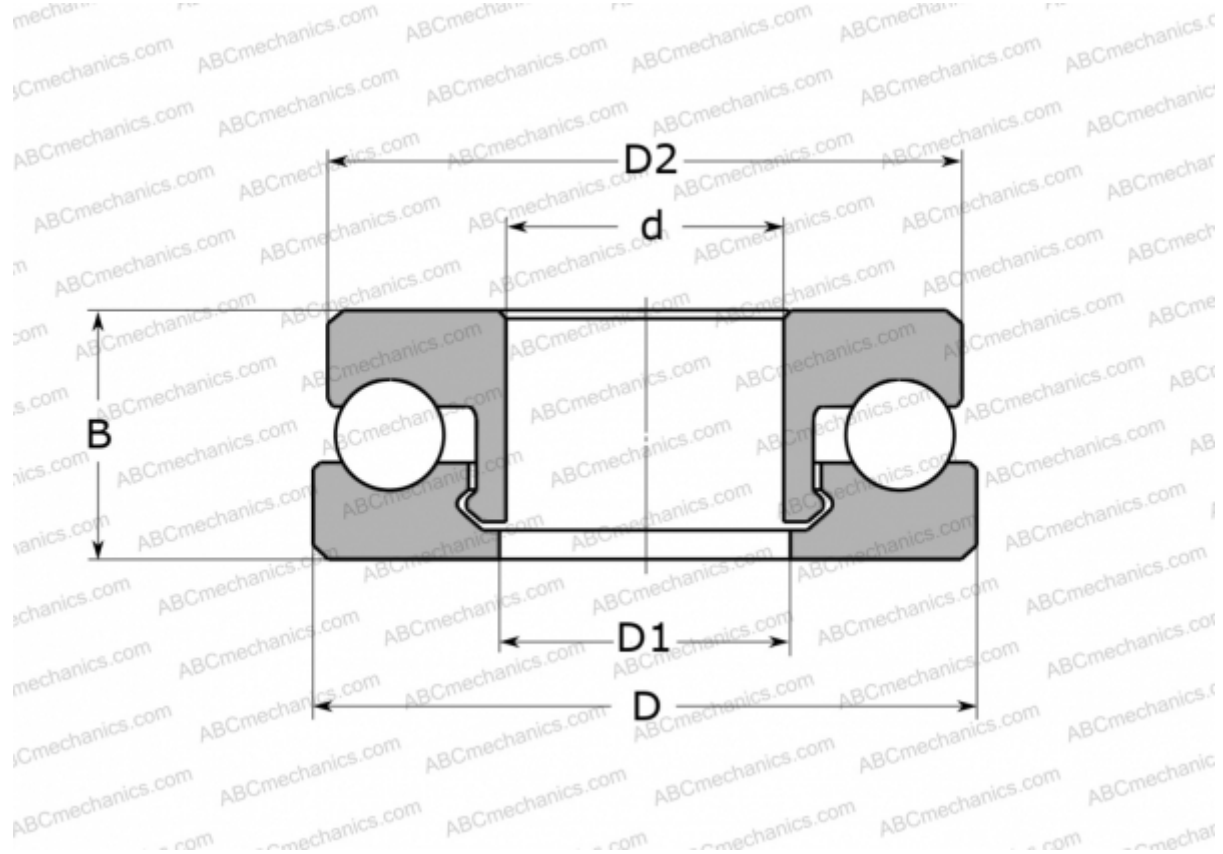

Technical specification

DIMENSIONS, MM

d	35,000
D	62,000
D1	36,000
D2	61,000
B	18,000

WEIGHT, KG 43,500

MANUFACTURER [SKF](#)

CALCULATION DATA

Basic dynamic load rating, C	0,960 kN
Basic static load rating, Co	0,765 kN
Limiting speed	335 r/min