

## 51108 V/HR11T1 SKF

Thrust ball bearings

TYPE: Ball bearings, Thrust ball bearing, Single direction, Polymer, stainless steel ball (SKF)

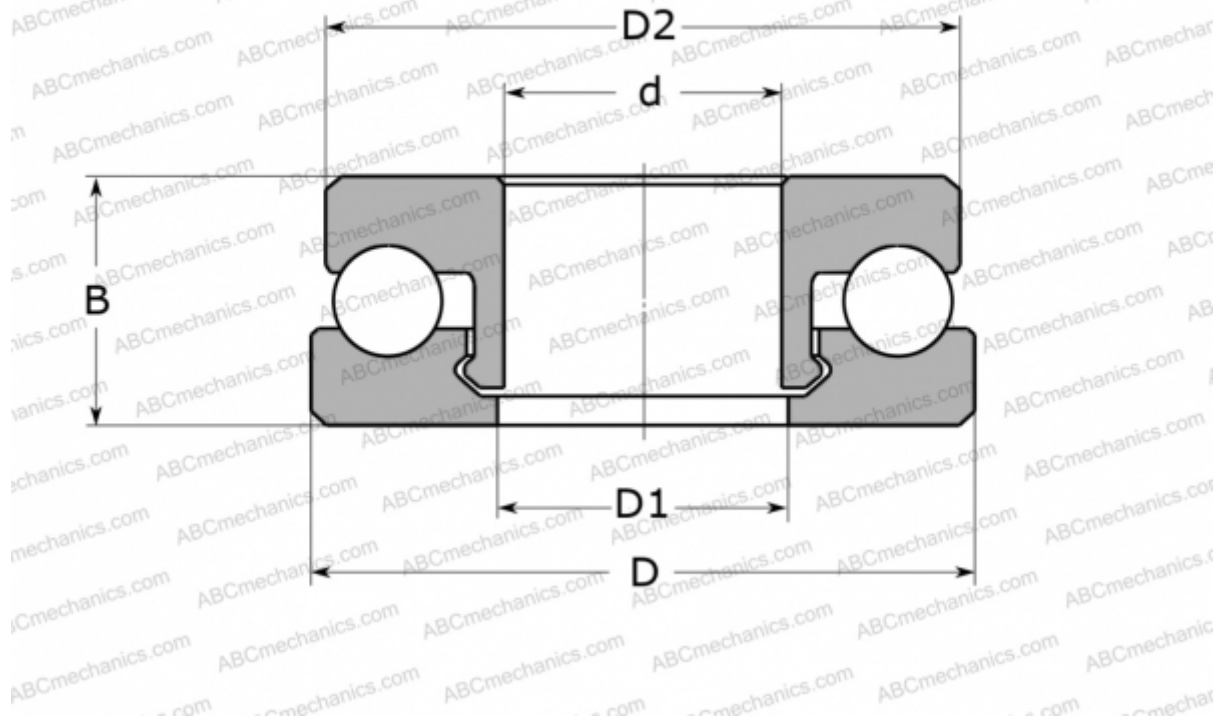

### Technical specification

#### DIMENSIONS, MM

d	40,000
D	60,000
D1	41,000
D2	59,000
B	13,000

**WEIGHT, KG** 29,500

**MANUFACTURER** [SKF](#)

#### CALCULATION DATA

Basic dynamic load rating, C	1,110 kN
Basic static load rating, Co	0,890 kN
Limiting speed	375 r/min