

## 51108 V/HR22T2 SKF

Thrust ball bearings

TYPE: Ball bearings, Thrust ball bearing, Single direction, Polymer, stainless steel ball (SKF)

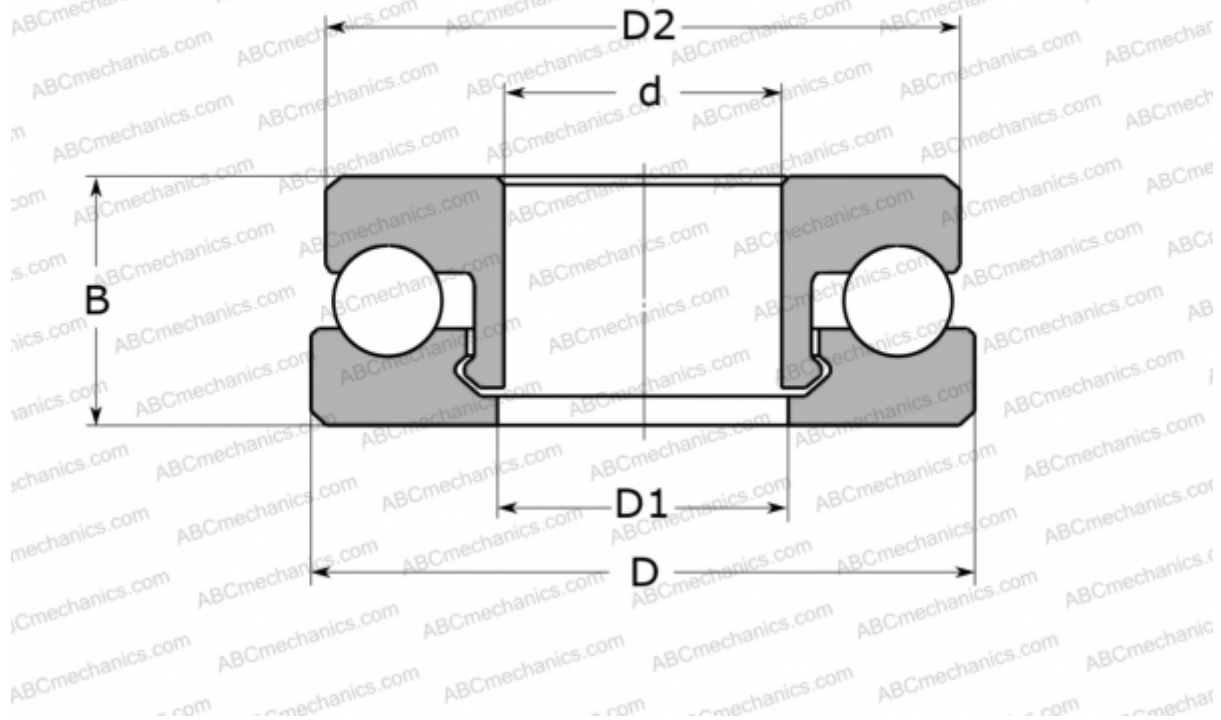

### Technical specification

#### DIMENSIONS, MM

d	40,000
D	60,000
D1	41,000
D2	59,000
B	13,000

**WEIGHT, KG** 22,500

**MANUFACTURER** [SKF](#)

#### CALCULATION DATA

Basic dynamic load rating, C	0,975 kN
Basic static load rating, Co	0,780 kN
Limiting speed	345 r/min