

51201 V/HR22Q2 SKF

Thrust ball bearings

TYPE: Ball bearings, Thrust ball bearing, Single direction, Polymer, glass ball (SKF)

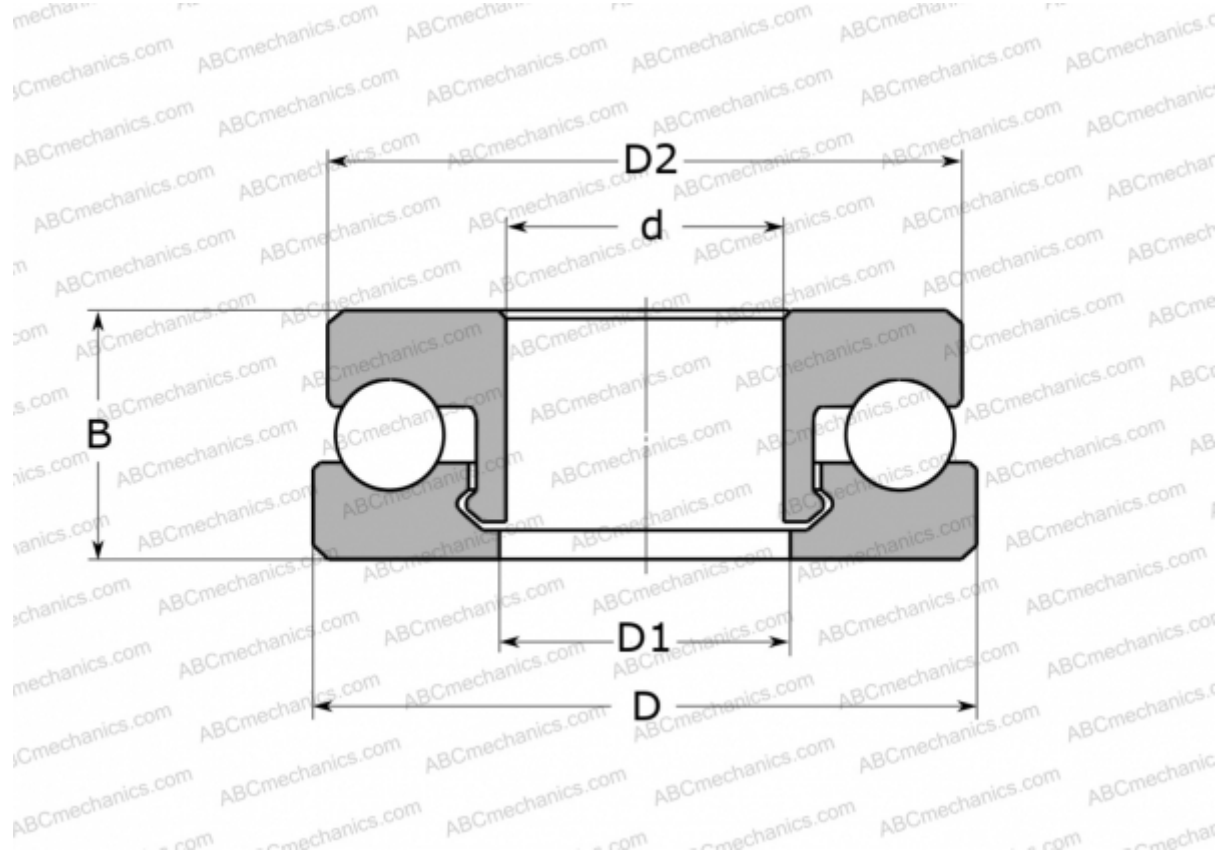

Technical specification

DIMENSIONS, MM

d	12,000
D	28,000
D1	13,000
D2	27,000
B	11,000

WEIGHT, KG 6,700

MANUFACTURER [SKF](#)

CALCULATION DATA

Basic dynamic load rating, C	0,360 kN
Basic static load rating, Co	0,290 kN
Limiting speed	500 r/min