

51102 V/HR22Q2 SKF

Thrust ball bearings

TYPE: Ball bearings, Thrust ball bearing, Single direction, Polymer, glass ball (SKF)

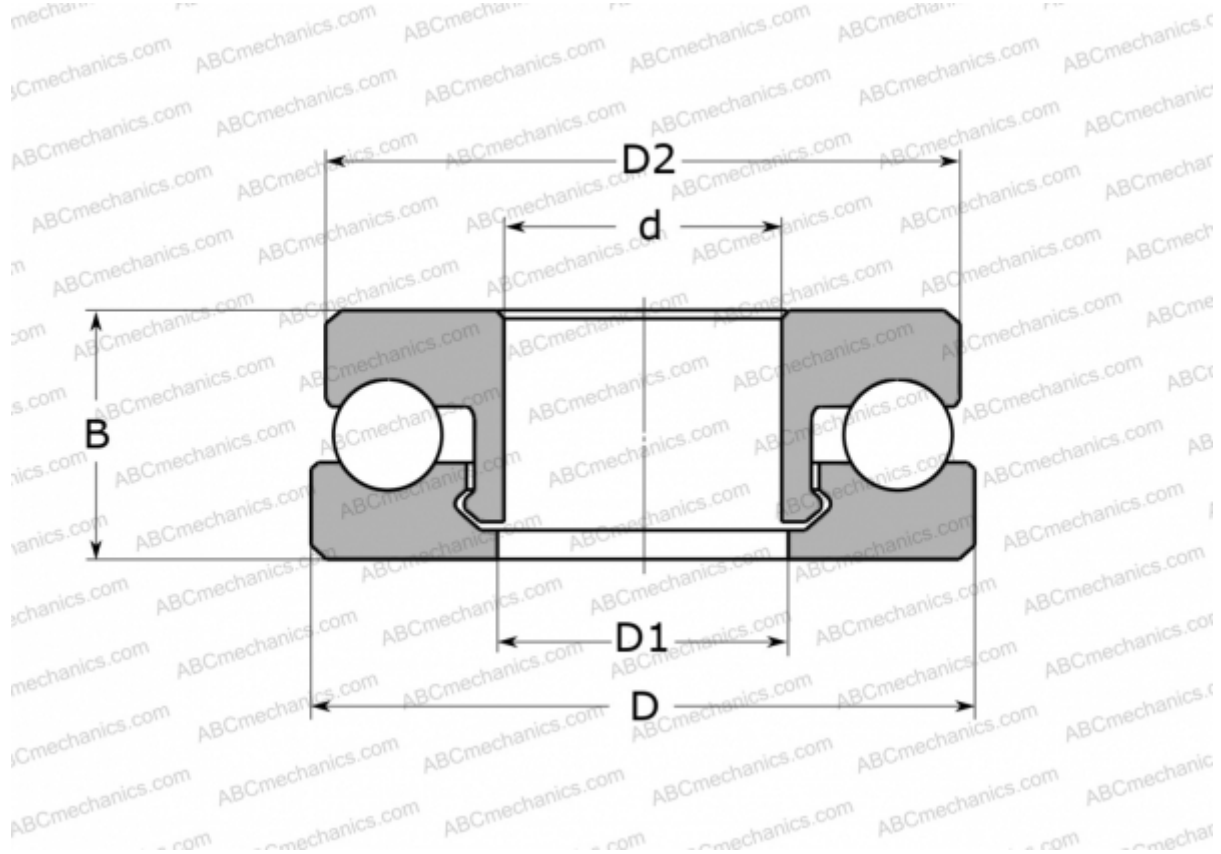

Technical specification

DIMENSIONS, MM

d	15,000
D	28,000
D1	16,000
D2	27,000
B	9,000

WEIGHT, KG 4,700

MANUFACTURER [SKF](#)

CALCULATION DATA

Basic dynamic load rating, C	0,550 kN
Basic static load rating, Co	0,440 kN
Limiting speed	460 r/min