

## 51109 V/HR22Q2 SKF

Thrust ball bearings

TYPE: Ball bearings, Thrust ball bearing, Single direction, Polymer, glass ball (SKF)

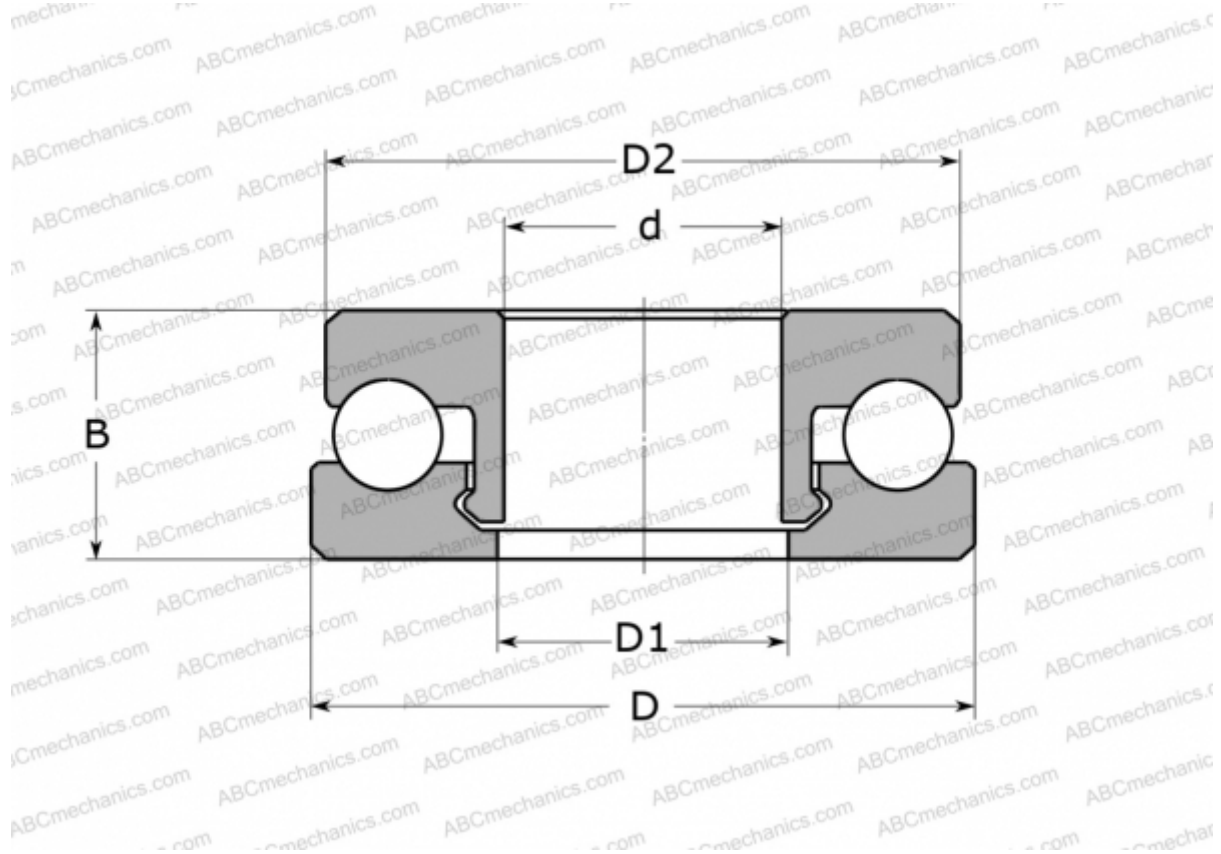

### Technical specification

#### DIMENSIONS, MM

d	45,000
D	65,000
D1	46,000
D2	64,000
B	14,000

**WEIGHT, KG** 27,500

**MANUFACTURER** [SKF](#)

#### CALCULATION DATA

Basic dynamic load rating, C	1,040 kN
Basic static load rating, Co	0,835 kN
Limiting speed	330 r/min