

NA 4900 SKF

Needle roller bearings

TYPE: Roller bearings, Needle, Single row, With machined rings with flanges, with an inner ring, Metric

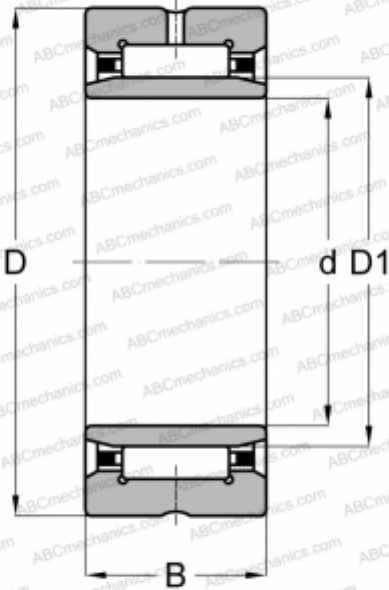

Technical specification

DIMENSIONS, MM

d	10,000
D	22,000
D1	14,000
B	13,000

WEIGHT, KG

0,023

MANUFACTURER

[SKF](#)

INTERCHANGE

ABC	NA 4900
FAG	NA 4900(NU 4900)
INA	NA 4900
IKO	NA 4900
TORRINGTON	NA 4900

CALCULATION DATA

Basic dynamic load rating, C	8,800 kN
Basic static load rating, Co	10,400 kN
Fatigue load limit, Pu	1,220 kN
Reference speed	24000 r/min
Limiting speed	28000 r/min