

## NA 4901 SKF

Needle roller bearings

TYPE: Roller bearings, Needle, Single row, With machined rings with flanges, with an inner ring, Metric

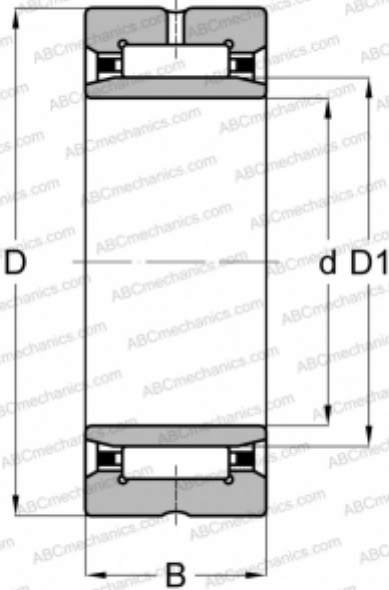

### Technical specification

#### DIMENSIONS, MM

d	12,000
D	24,000
D1	16,000
B	13,000

#### WEIGHT, KG

0,026

#### MANUFACTURER

[SKF](#)

#### INTERCHANGE

ABC	<a href="#">NA 4901</a>
FAG	<a href="#">NA 4901(NU 4901)</a>
INA	<a href="#">NA 4901</a>
IKO	<a href="#">NA 4901</a>
TORRINGTON	<a href="#">NA 4901</a>

#### CALCULATION DATA

Basic dynamic load rating, C	9,900 kN
Basic static load rating, Co	12,200 kN
Fatigue load limit, Pu	1,460 kN
Reference speed	22000 r/min
Limiting speed	26000 r/min