

NKI 20/20 SKF

Needle roller bearings

TYPE: Roller bearings, Needle, Single row, With machined rings with flanges, with an inner ring, Metric

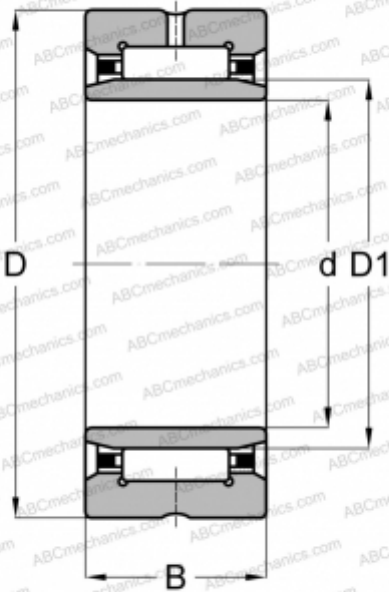

Technical specification

DIMENSIONS, MM

d	20,000
D	32,000
D1	24,000
B	20,000

WEIGHT, KG

0,060

MANUFACTURER

[SKF](#)

INTERCHANGE

ABC	NKI 20/20
FAG	NKI 20/20
INA	NKI 20/20
IKO	TAFI 203220

CALCULATION DATA

Basic dynamic load rating, C	19,000 kN
Basic static load rating, Co	32,500 kN
Fatigue load limit, Pu	4,000 kN
Reference speed	16000 r/min
Limiting speed	19000 r/min

REPLACES

NA 2322