

NKI 25/30 SKF

Needle roller bearings

TYPE: Roller bearings, Needle, Single row, With machined rings with flanges, with an inner ring, Metric

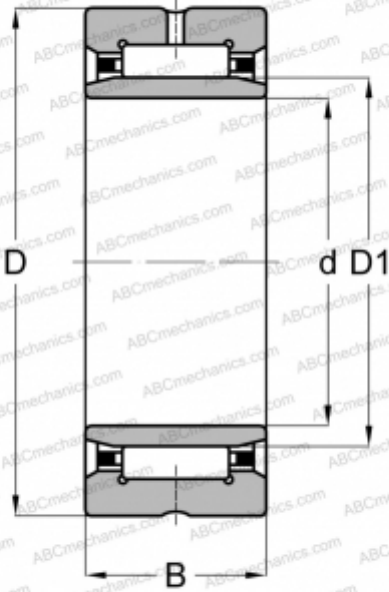

Technical specification

DIMENSIONS, MM

d	25,000
D	38,000
D1	29,000
B	30,000

WEIGHT, KG

0,120

MANUFACTURER

[SKF](#)

INTERCHANGE

ABC	NKI 25/30
FAG	NKI 25/30
INA	NKI 25/30
IKO	TAFI 253830

CALCULATION DATA

Basic dynamic load rating, C	31,900 kN
Basic static load rating, Co	60,000 kN
Fatigue load limit, Pu	7,500 kN
Reference speed	14000 r/min
Limiting speed	15000 r/min

REPLACES

NA 25383