

## NA 4826 SKF

Needle roller bearings

TYPE: Roller bearings, Needle, Single row, With machined rings with flanges, with an inner ring, Metric

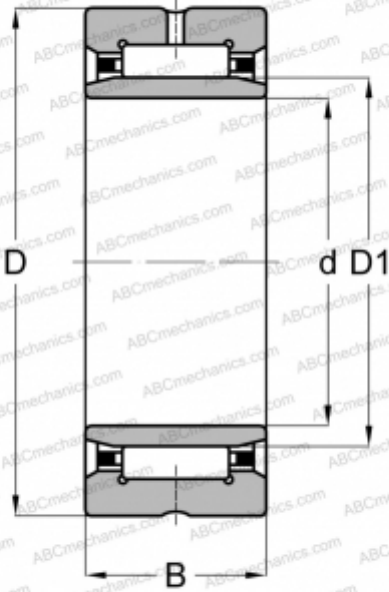

### Technical specification

#### DIMENSIONS, MM

d	130,000
D	165,000
D1	145,000
B	35,000

#### WEIGHT, KG

1,800

#### MANUFACTURER

[SKF](#)

#### INTERCHANGE

ABC	<a href="#">NA 4826</a>
FAG	<a href="#">NA 4826</a>
INA	<a href="#">NA 4826</a>
IKO	<a href="#">NA 4826</a>
TORRINGTON	<a href="#">NA 4826</a>

#### CALCULATION DATA

Basic dynamic load rating, C	119,000 kN
Basic static load rating, Co	325,000 kN
Fatigue load limit, Pu	36,500 kN
Reference speed	2800 r/min
Limiting speed	3200 r/min