

RNA 6906 IKO

Needle roller bearings

TYPE: Roller bearings, Needle, Double row, With machined rings with flanges, without an inner ring, Metric

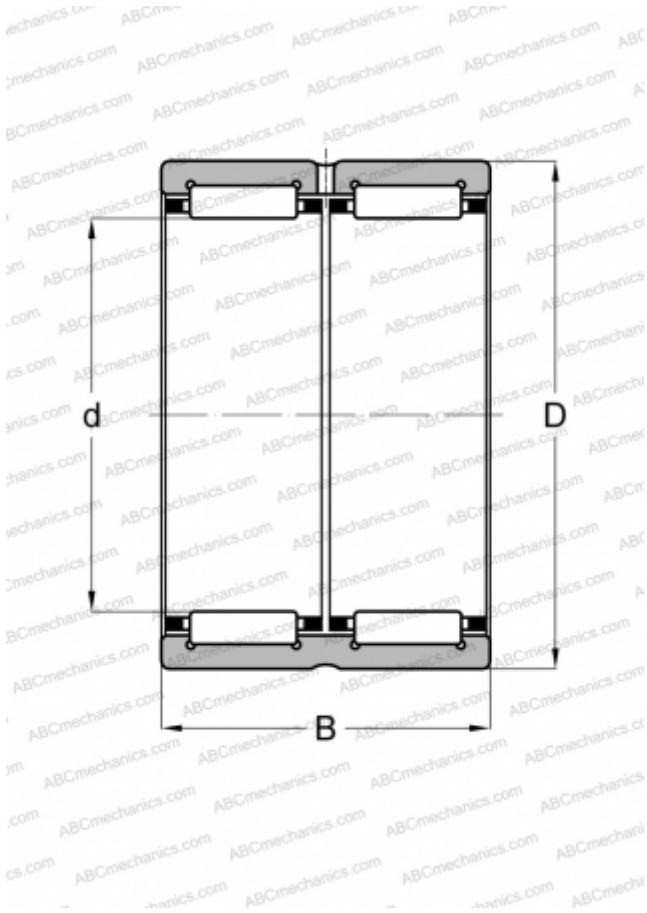

Technical specification

DIMENSIONS, MM

d	35,000
D	47,000
B	30,000

WEIGHT, KG

0,125

MANUFACTURER

[IKO](#)

INTERCHANGE

ABC	RNA 6906
-----	--------------------------

CALCULATION DATA

Basic dynamic load rating, C	43,000 kN
Basic static load rating, Co	69,000 kN