

RNA 6907 SKF

Needle roller bearings

TYPE: Roller bearings, Needle, Double row, With machined rings with flanges, without an inner ring, Metric

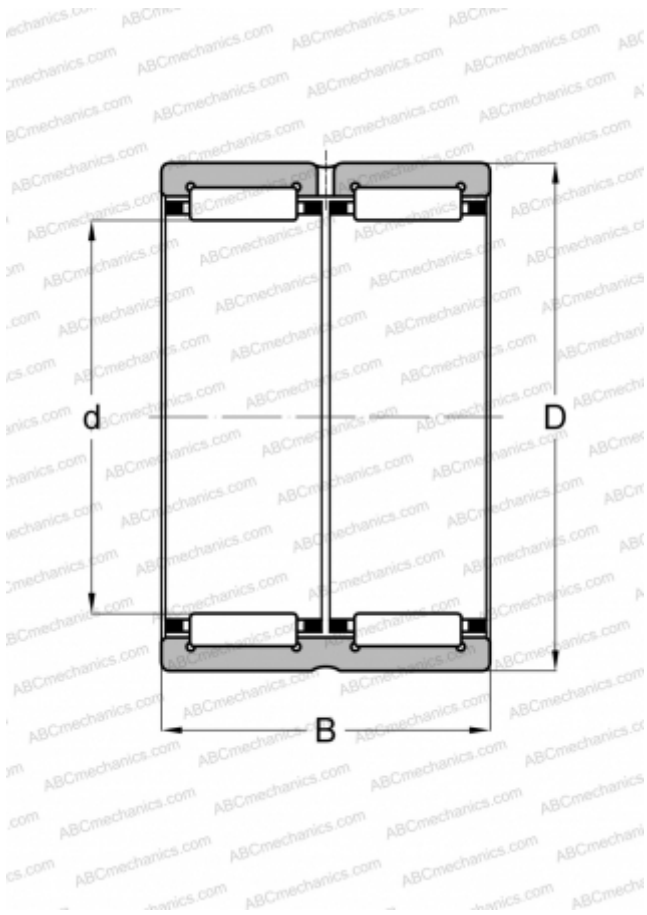

Technical specification

DIMENSIONS, MM

d	42,000
D	55,000
B	36,000

WEIGHT, KG

0,190

MANUFACTURER

[SKF](#)

INTERCHANGE

ABC	RNA 6907
IKO	RNA 6907
FAG	RNA 6907
INA	RNA 6907-ZW
TORRINGTON	RNA 6907

CALCULATION DATA

Basic dynamic load rating, C	48,400 kN
Basic static load rating, Co	93,000 kN
Fatigue load limit, Pu	11,400 kN
Reference speed	9500 r/min
Limiting speed	11000 r/min

REPLACES

RNNA 6907

ASSOCIATED PRODUCTS

CR 42x55x7 HMS5 RG