

RNA 6908 ABC

Needle roller bearings

TYPE: Roller bearings, Needle, Double row, With machined rings with flanges, without an inner ring, Metric

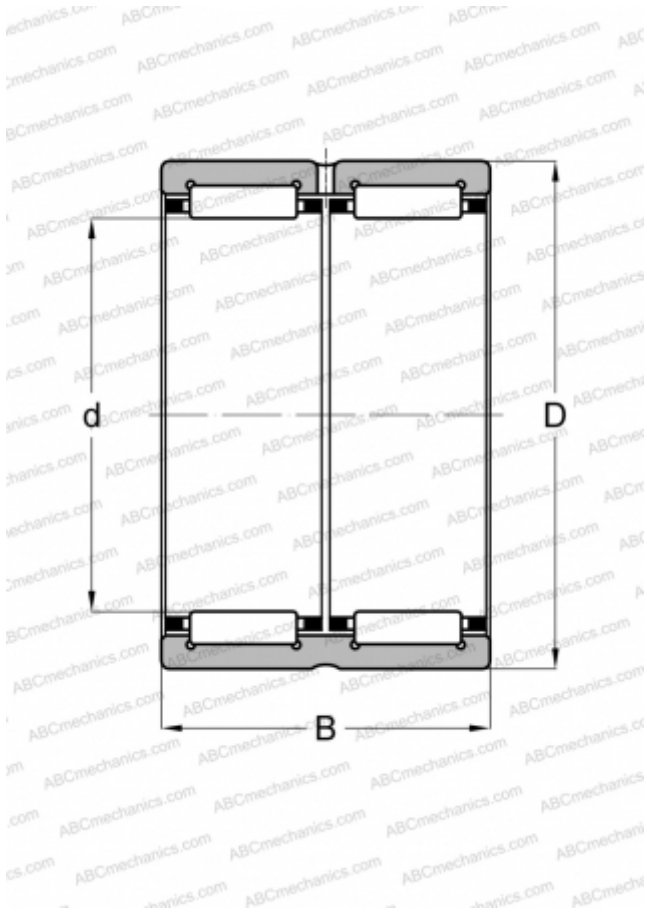

Technical specification

DIMENSIONS, MM

d	48,000
D	62,000
B	40,000

WEIGHT, KG

0,304

MANUFACTURER

[ABC](#)

INTERCHANGE

IKO	RNA 6908
FAG	RNA 6908
INA	RNA 6908-ZW
SKF	RNA 6908
TORRINGTON	RNA 6908