

RNA 6908 SKF

Needle roller bearings

TYPE: Roller bearings, Needle, Double row, With machined rings with flanges, without an inner ring, Metric

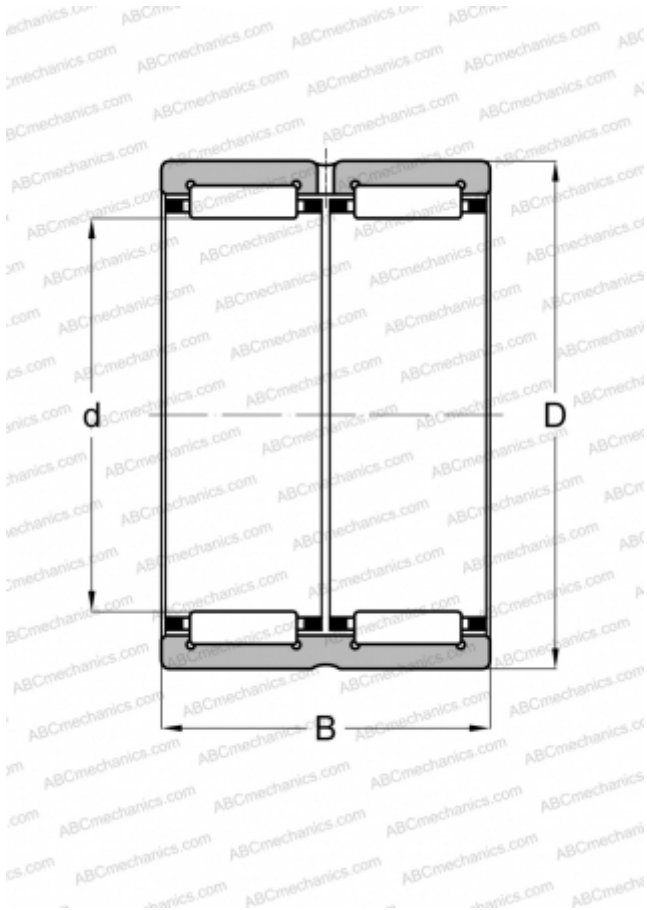

Technical specification

DIMENSIONS, MM

d	48,000
D	62,000
B	40,000

WEIGHT, KG

0,260

MANUFACTURER

[SKF](#)

INTERCHANGE

ABC	RNA 6908
IKO	RNA 6908
FAG	RNA 6908
INA	RNA 6908-ZW
TORRINGTON	RNA 6908

CALCULATION DATA

Basic dynamic load rating, C	67,100 kN
Basic static load rating, Co	125,000 kN
Fatigue load limit, Pu	15,300 kN
Reference speed	8000 r/min
Limiting speed	9500 r/min

REPLACES

RNNA 6908

ASSOCIATED PRODUCTS

CR 48x62x8 HMS5 RG