

RNA 6909 TORRINGTON

Needle roller bearings

TYPE: Roller bearings, Needle, Double row, With machined rings with flanges, without an inner ring, Metric

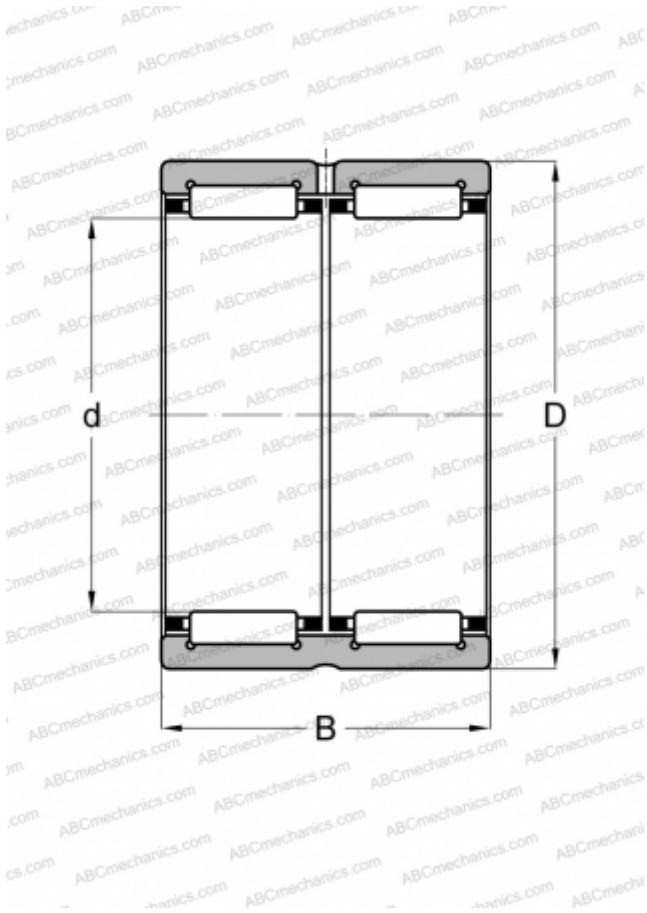

Technical specification

DIMENSIONS, MM

d	52,000
D	68,000
B	40,000

WEIGHT, KG

0,395

MANUFACTURER

[TORRINGTON](#)

INTERCHANGE

ABC	RNA 6909
IKO	RNA 6909
FAG	RNA 6909
INA	RNA 6909-ZW
SKF	RNA 6909