

## RNA 6910 IKO

Needle roller bearings

TYPE: Roller bearings, Needle, Double row, With machined rings with flanges, without an inner ring, Metric

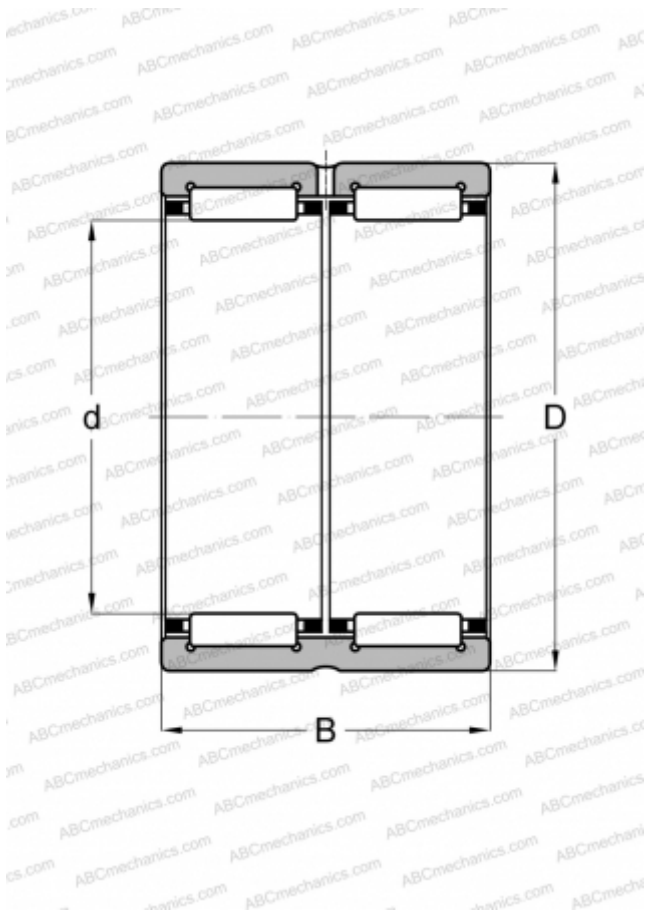

### Technical specification

#### DIMENSIONS, MM

d	58,000
D	72,000
B	40,000

#### WEIGHT, KG

0,320

#### MANUFACTURER

[IKO](#)

#### INTERCHANGE

ABC	<a href="#">RNA 6910</a>
FAG	<a href="#">RNA 6910</a>
INA	<a href="#">RNA 6910-ZW</a>
SKF	<a href="#">RNA 6910</a>
TORRINGTON	<a href="#">RNA 6910</a>

#### CALCULATION DATA

Basic dynamic load rating, C	79,200 kN
Basic static load rating, Co	164,000 kN