

RNA 6910 SKF

Needle roller bearings

TYPE: Roller bearings, Needle, Double row, With machined rings with flanges, without an inner ring, Metric

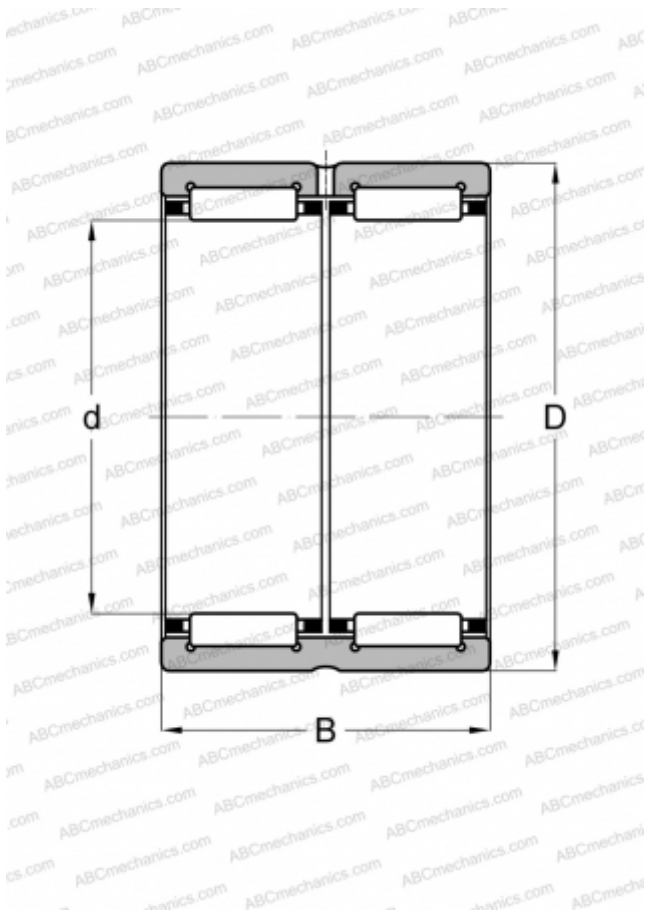

Technical specification

DIMENSIONS, MM

d	58,000
D	72,000
B	40,000

WEIGHT, KG

0,310

MANUFACTURER

[SKF](#)

INTERCHANGE

ABC	RNA 6910
IKO	RNA 6910
FAG	RNA 6910
INA	RNA 6910-ZW
TORRINGTON	RNA 6910

CALCULATION DATA

Basic dynamic load rating, C	73,700 kN
Basic static load rating, Co	150,000 kN
Fatigue load limit, Pu	18,600 kN
Reference speed	7000 r/min
Limiting speed	8000 r/min

REPLACES

RNNA 6910

ASSOCIATED PRODUCTS

CR 58x72x8 HMS5 RG