

RNA 6912 ABC

Needle roller bearings

TYPE: Roller bearings, Needle, Double row, With machined rings with flanges, without an inner ring, Metric

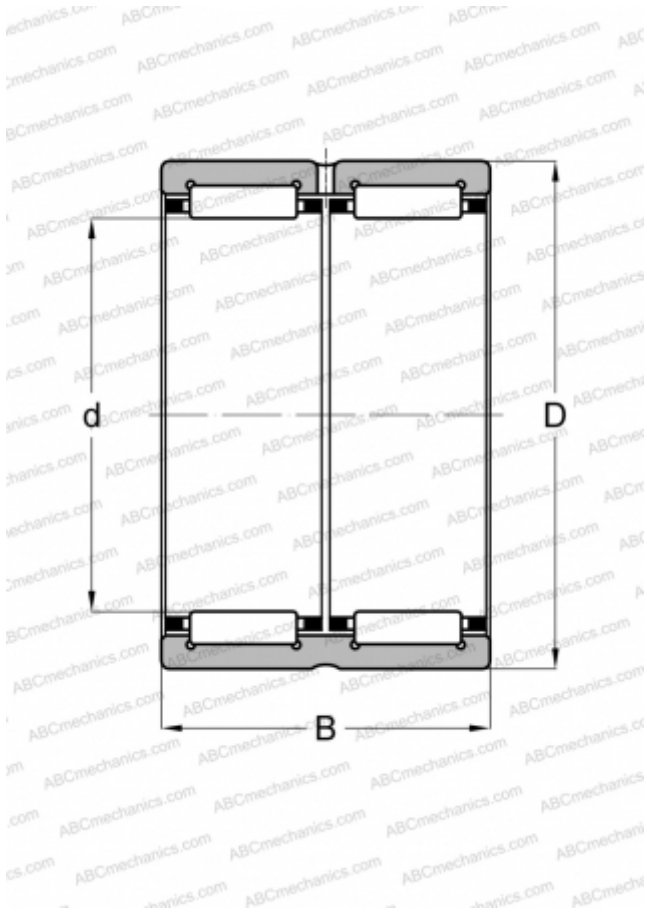

Technical specification

DIMENSIONS, MM

d	68,000
D	85,000
B	45,000

WEIGHT, KG

0,572

MANUFACTURER

[ABC](#)

INTERCHANGE

IKO	RNA 6912
FAG	RNA 6912
INA	RNA 6912-ZW
SKF	RNA 6912
TORRINGTON	RNA 6912