

RNA 6913 SKF

Needle roller bearings

TYPE: Roller bearings, Needle, Double row, With machined rings with flanges, without an inner ring, Metric

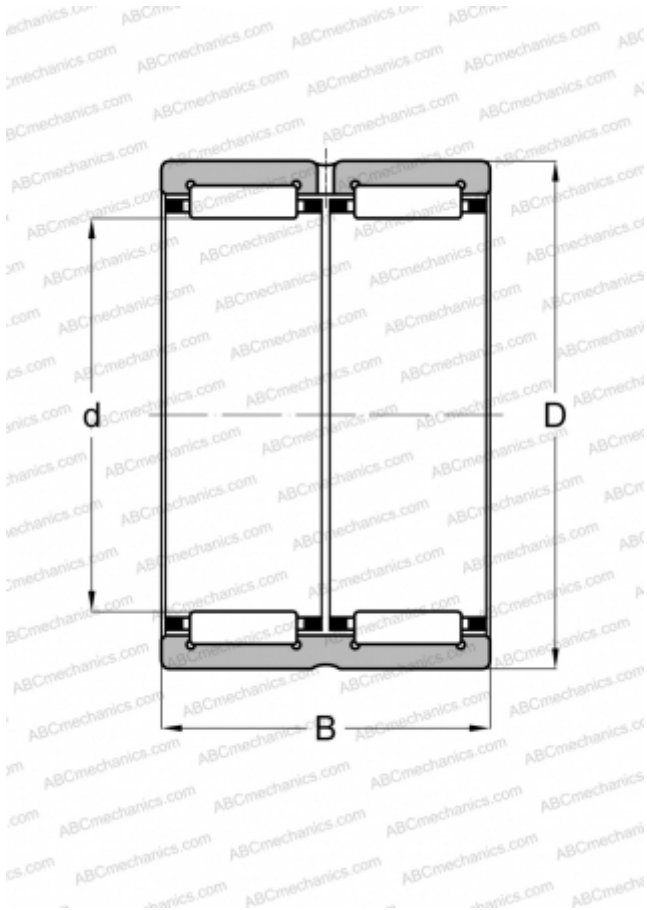

Technical specification

DIMENSIONS, MM

d	72,000
D	90,000
B	45,000

WEIGHT, KG

0,580

MANUFACTURER

[SKF](#)

INTERCHANGE

ABC	RNA 6913
IKO	RNA 6913
FAG	RNA 6913
INA	RNA 6913-ZW
TORRINGTON	RNA 6913

CALCULATION DATA

Basic dynamic load rating, C	95,200 kN
Basic static load rating, Co	212,000 kN
Fatigue load limit, Pu	26,000 kN
Reference speed	5600 r/min
Limiting speed	6300 r/min

REPLACES

RNNA 6913

ASSOCIATED PRODUCTS

CR 72x90x10 HMS5 RG