

RNA 6913 TORRINGTON

Needle roller bearings

TYPE: Roller bearings, Needle, Double row, With machined rings with flanges, without an inner ring, Metric

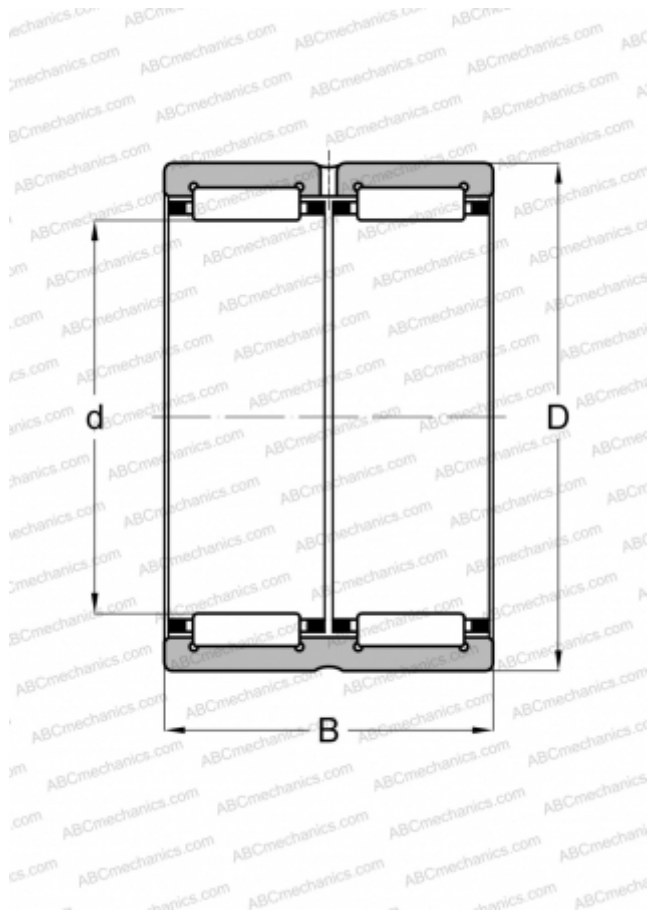

Technical specification

DIMENSIONS, MM

d	72,000
D	90,000
B	45,000

WEIGHT, KG

0,667

MANUFACTURER

[TORRINGTON](#)

INTERCHANGE

ABC	RNA 6913
IKO	RNA 6913
FAG	RNA 6913
INA	RNA 6913-ZW
SKF	RNA 6913