

RNA 6914 TORRINGTON

Needle roller bearings

TYPE: Roller bearings, Needle, Double row, With machined rings with flanges, without an inner ring, Metric

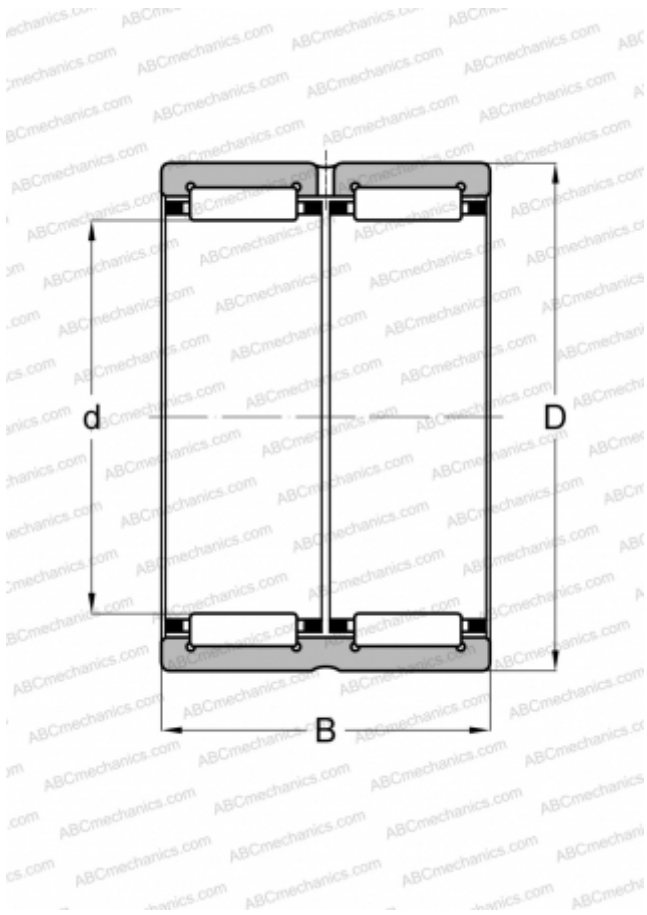

Technical specification

DIMENSIONS, MM

d	80,000
D	100,000
B	54,000

WEIGHT, KG

0,948

MANUFACTURER

[TORRINGTON](#)

INTERCHANGE

ABC	RNA 6914
IKO	RNA 6914
FAG	RNA 6914
INA	RNA 6914-ZW
SKF	RNA 6914