

RNA 6916 SKF

Needle roller bearings

TYPE: Roller bearings, Needle, Double row, With machined rings with flanges, without an inner ring, Metric

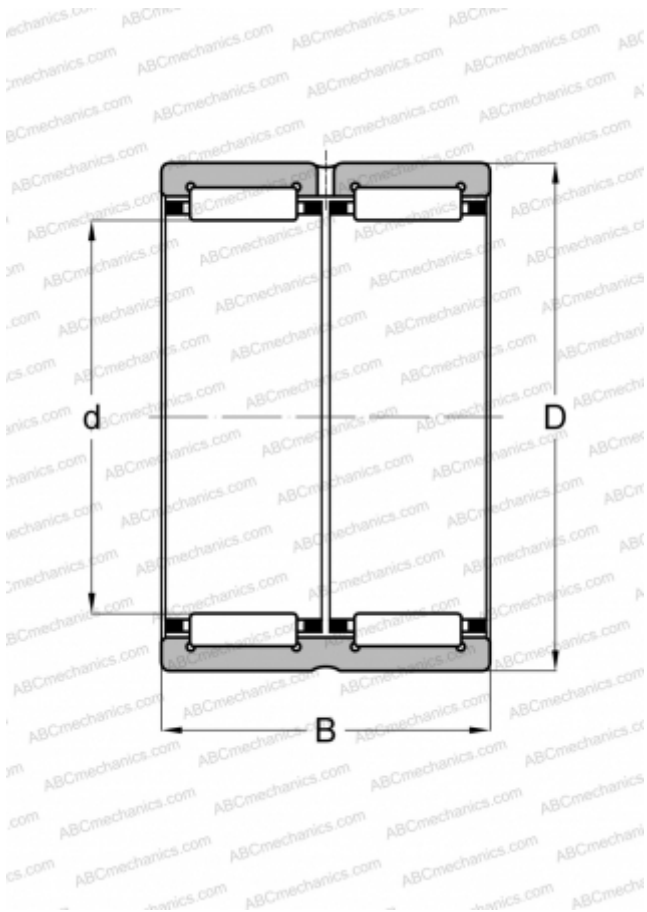

Technical specification

DIMENSIONS, MM

d	90,000
D	110,000
B	54,000

WEIGHT, KG

0,990

MANUFACTURER

[SKF](#)

INTERCHANGE

ABC	RNA 6916
IKO	RNA 6916
FAG	RNA 6916
INA	RNA 6916-ZW
TORRINGTON	RNA 6916

CALCULATION DATA

Basic dynamic load rating, C	134,000 kN
Basic static load rating, Co	315,000 kN
Fatigue load limit, Pu	40,000 kN
Reference speed	4500 r/min
Limiting speed	5000 r/min

REPLACES

RNNA 6916

ASSOCIATED PRODUCTS

CR 90x110x10 HMS5 RG